

Technische Daten



Spiegelverkehrte Montage möglich.

Artikelnummer:

234 100

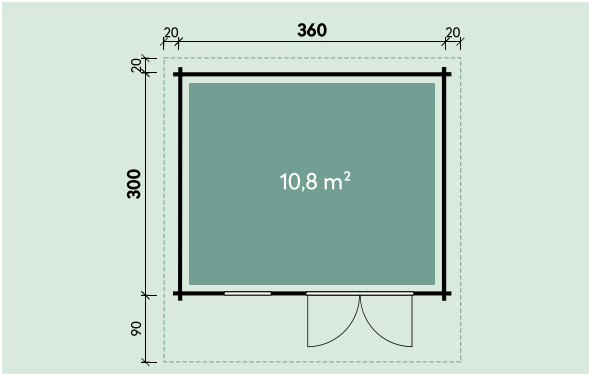

Kontrolliert durch:

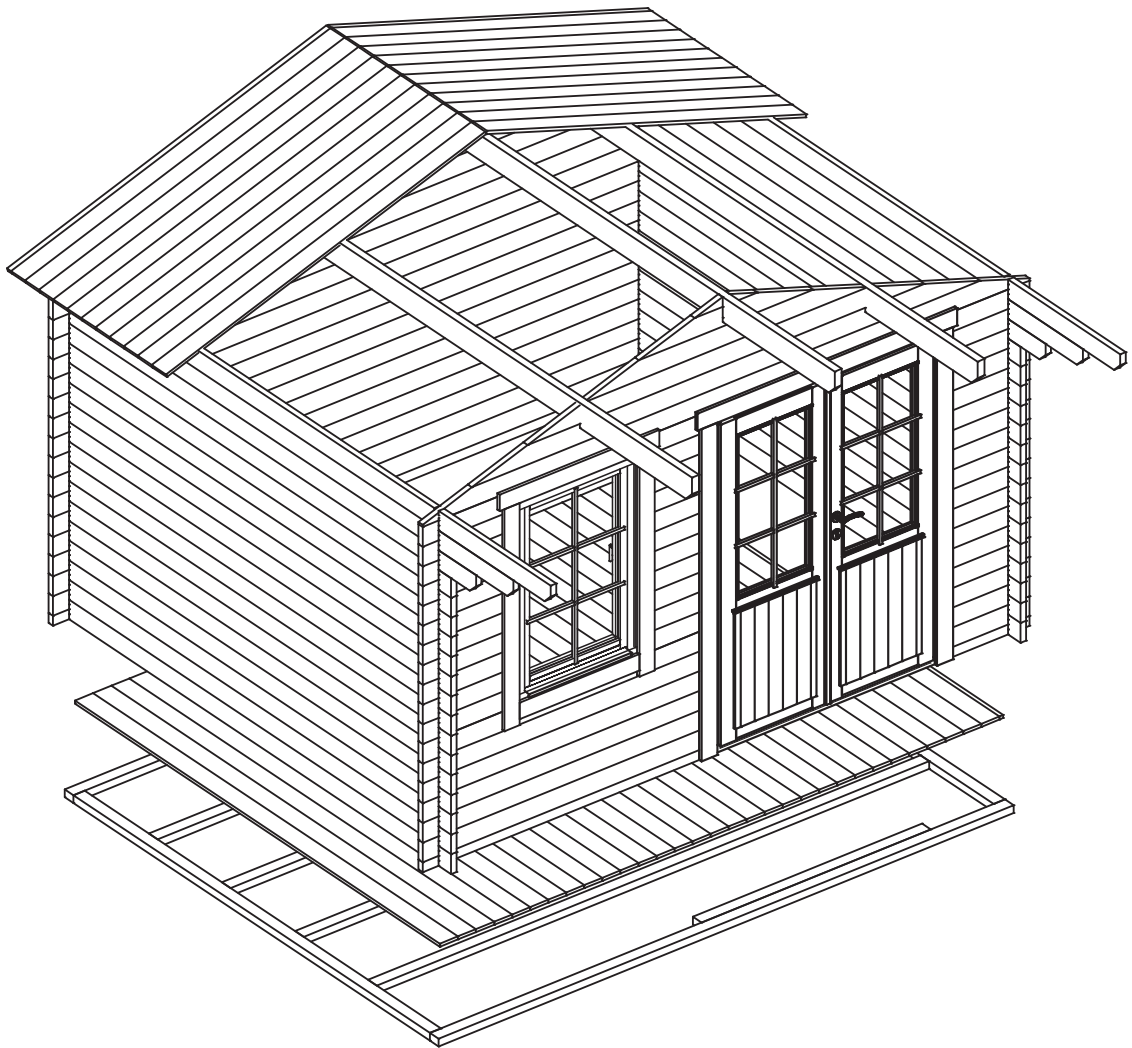

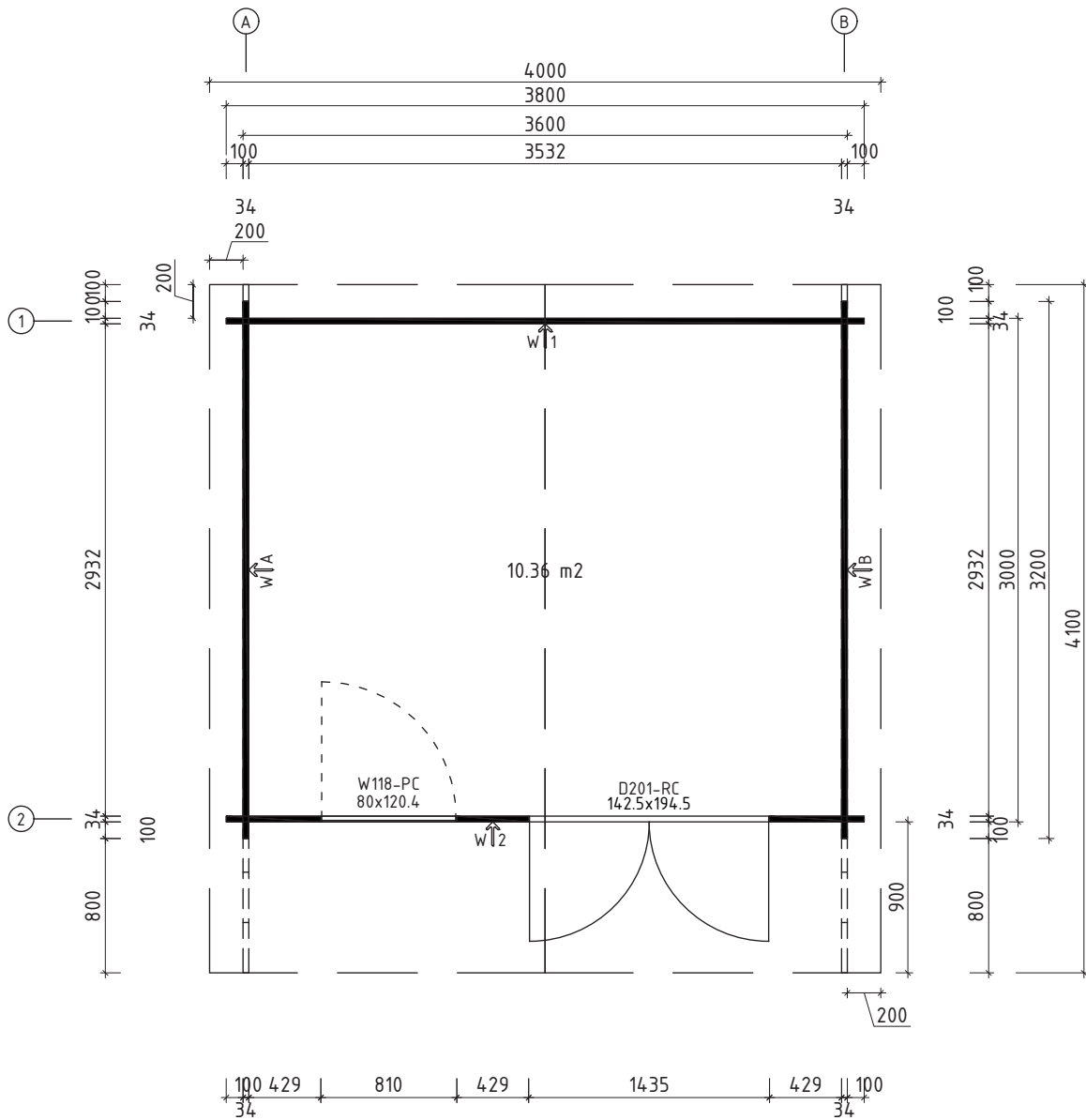





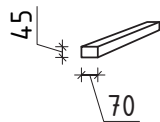
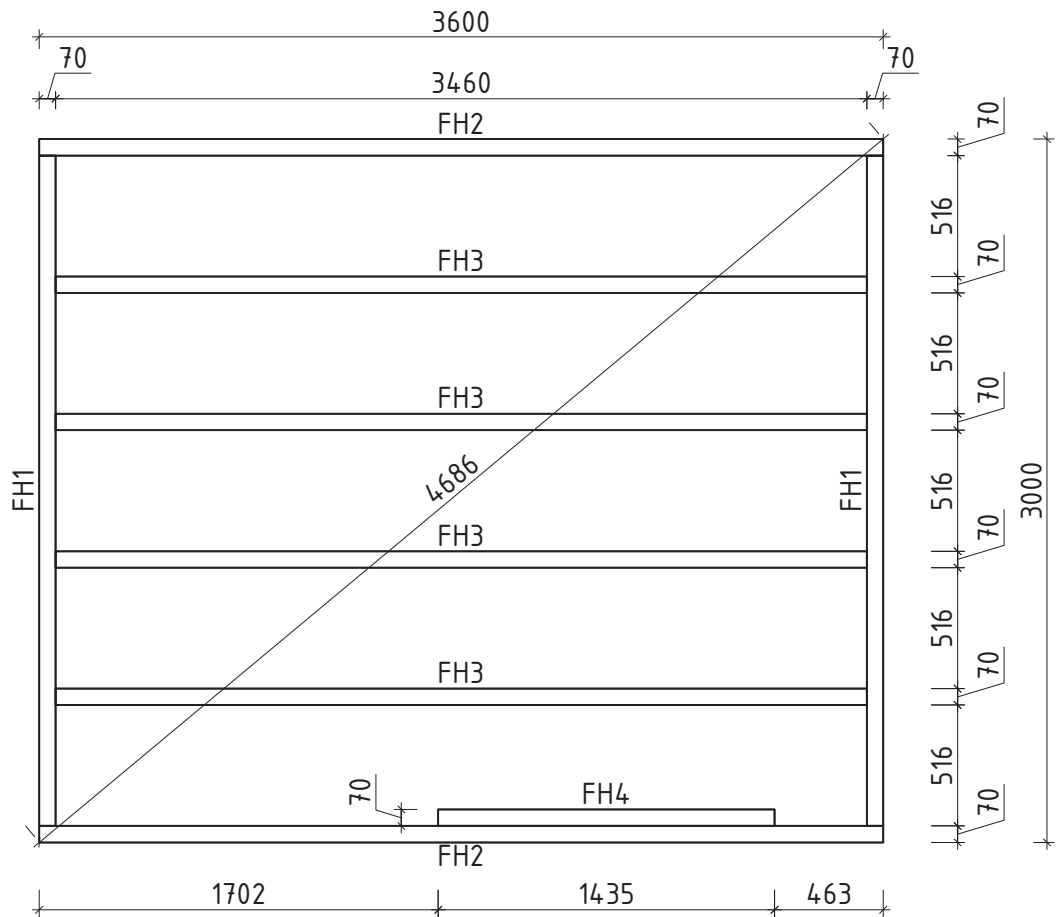



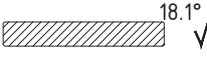











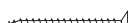

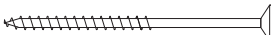
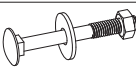

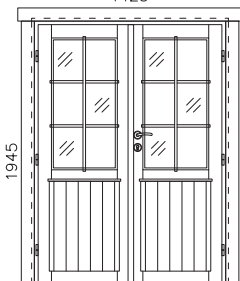
Q4 – Qualitätsklasse für Fenster und Türen

Wir empfehlen als Fundament für Ihr Gartenhaus eine vollflächig festgegründete, gepflasterte oder betonierte Fläche. Wahlweise ist auch ein Punkt- oder Streifenfundament möglich.



Pos	Teileliste 234100	Stck	Profil (mm)	Länge (mm)
001		1	34x114	4100
002		1	34x114	4100
004		17	34x114	3800
005		1	34x57	3800
006		2	34x114	3700
007		2	34x114	3400
008		30	34x114	3200
011		1	34x57	1802
012		6	34x114	1802
015		1	34x57	563
016		28	34x114	563
017		11	34x114	429
W1-1		1		
W2-1		1		
FH2	FUNDAMENTHÖLZER (imprägniert) 	2	70x45	3600
FH3	FUNDAMENTHÖLZER (imprägniert) 	4	70x45	3460
FH1	FUNDAMENTHÖLZER (imprägniert) 	2	70x45	2860
FH4	FUNDAMENTHÖLZER (imprägniert) 	1	70x45	1435
PF1	PFETTEN 	2	44x145	4100
PF2	PFETTEN 	1	44x145	4100
	DACHBRETTER	74+1	113x18	2105
	FUSSBODENBRETTER	32+1	113x18	2925
	FUSSBODENLEISTEN	✓	18x40	15.0lfm

Pos	Teileliste 234100		Stck	Profil (mm)	Länge (mm)
G02-1	GIEBELBRETTER 18x120		4	18x120	2185
G06-1	GIEBELDECKLEISTEN 18x58		4	18x58	2185
T06-1	TRAUFLNLEISTEN 18x40			18x40	8.5lfm
T01-1	TRAUFBRETTER 18x95		2	18x95	4100
GS	Giebelsegment		2		
SM-1	Sturmleisten		4	18x40	1940
SH	Schlaghölzer		3		
NG2 550	NÄGEL 2.5x50 Dachbretter		444		
NG2 550	NÄGEL 2.5x50 Fussbodenbretter		384		
SR3 030	SCHRAUBEN 3.0x30 Fussbodenleisten		26		
SR3 030	SCHRAUBEN 3.0x30 Traufenleisten		18		
SR3 545	SCHRAUBEN 3.5x45 Giebelbretter		20		
SR3 545	SCHRAUBEN 3.5x45 Giebeldeckleisten		20		
SR3 545	SCHRAUBEN 3.5x45 Giebelsegment		4		
SR3 545	SCHRAUBEN 3.5x45 Traufenbretter		18		
SR5 0100	SCHRAUBEN 5.0x100 Fundamenthölzer		36		
SS024	Schloßschrauben M8x70 Mutter M8 U-Scheibe Ø25 - Befestigung für Sturmleisten		12		
	✓ - bitte selber anpassen (falls nötig)!				

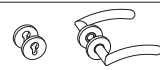
Pos	Teileliste 234100	Stck	Profil (mm)	Länge (mm)	
	<p>TÜR 1425x1945 D4-D34R-56C-14251945</p> <p>Q4 D201-RC 1425</p>  <div style="border: 1px solid black; padding: 5px; margin-top: 10px;"> <p>Right handed / DIN rechts / paremakäeline</p> <p>Clear opening/ durchgangsmaß/ ava suurus 1297x1837mm</p> <p>double-pane clear float glass ISO Glas 2-fach 2x klaaspakett, kirkas klaas</p> </div>	1			
PROSS H41-2	Q4-1 Muntins - Sprossen - Prossid horizontal 18x18		4	18x18	497
PRO SS V42-2	Q4-2 Muntins - Sprossen - Prossid vertical 18x18		2	18x18	975
PL3-4	Trims - Rahmenleisten - Piirdeliistud 18x95	 ✓	4	18x95	1925
PL3-5	Trims - Rahmenleisten - Piirdeliistud 18x95	 ✓	2	18x95	1625
SR30 20-01	3.0x20 Locking plate - Schließblech - Riivi vastus 02 Q4		2		
SR30 22-01	3.0x20ÜP Muntins - Sprossen - Prossid		12		
SR35 45-01	3.5x45 Trims - Rahmleisten - Piirdeliistud		24		
SR50 90-01	5.0x90 Door frames - Türrahmen - Ukselengid		8		
RV02	Locking plate - Schließblech - Riivi vastus 02 Q4		1		
LS-Q4	Q4 Cylinder lock - Zylinderschloss - Lukusüdamik		1		
UL-Q4	Q4 Door handle - Türgriff - Ukselink		1		

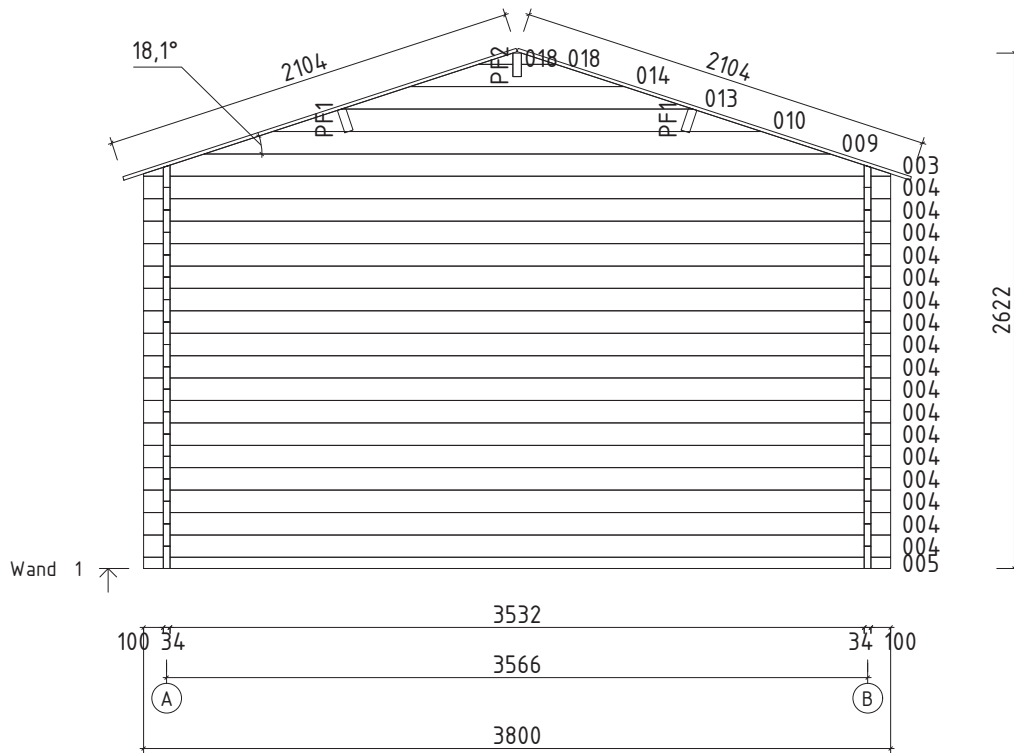
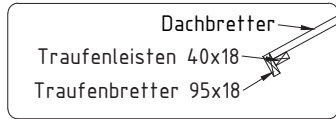

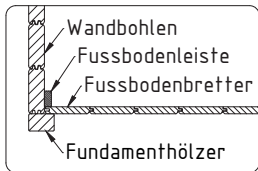
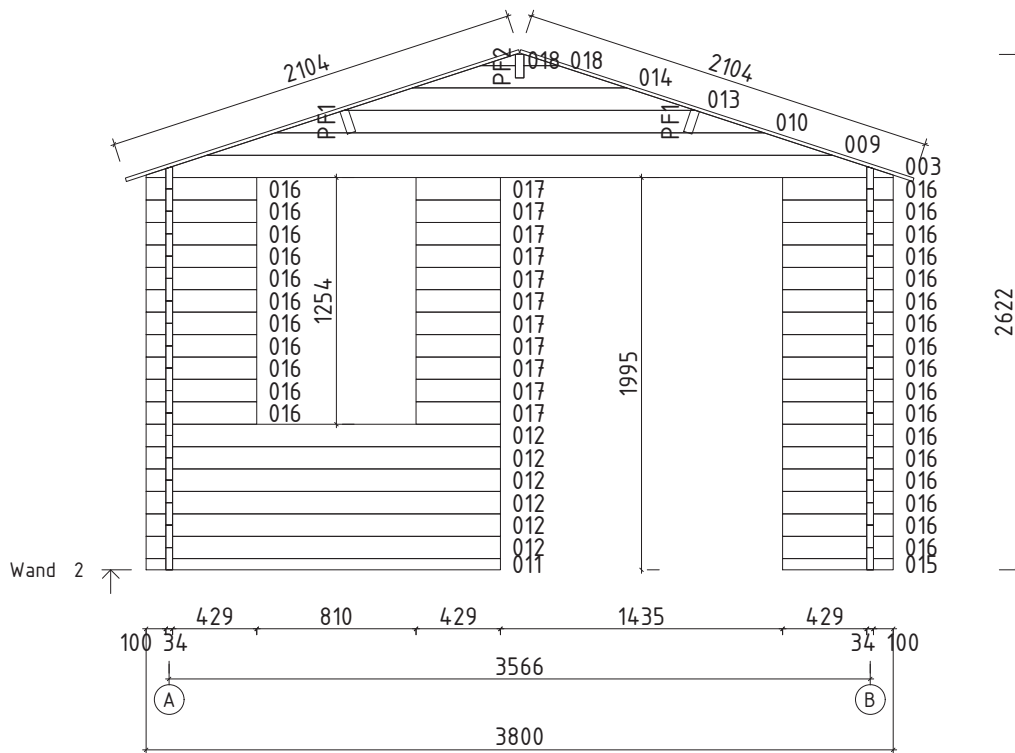

Veeplekk / Window sill / Fensterbank

Q4

