

Technische Daten



Spiegelverkehrte Montage möglich.

Artikelnummer:

240 480

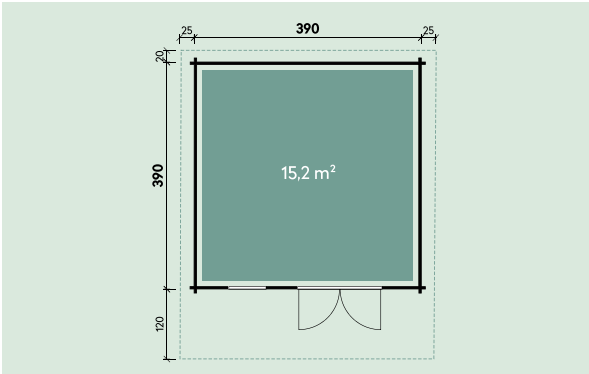

Kontrolliert durch:

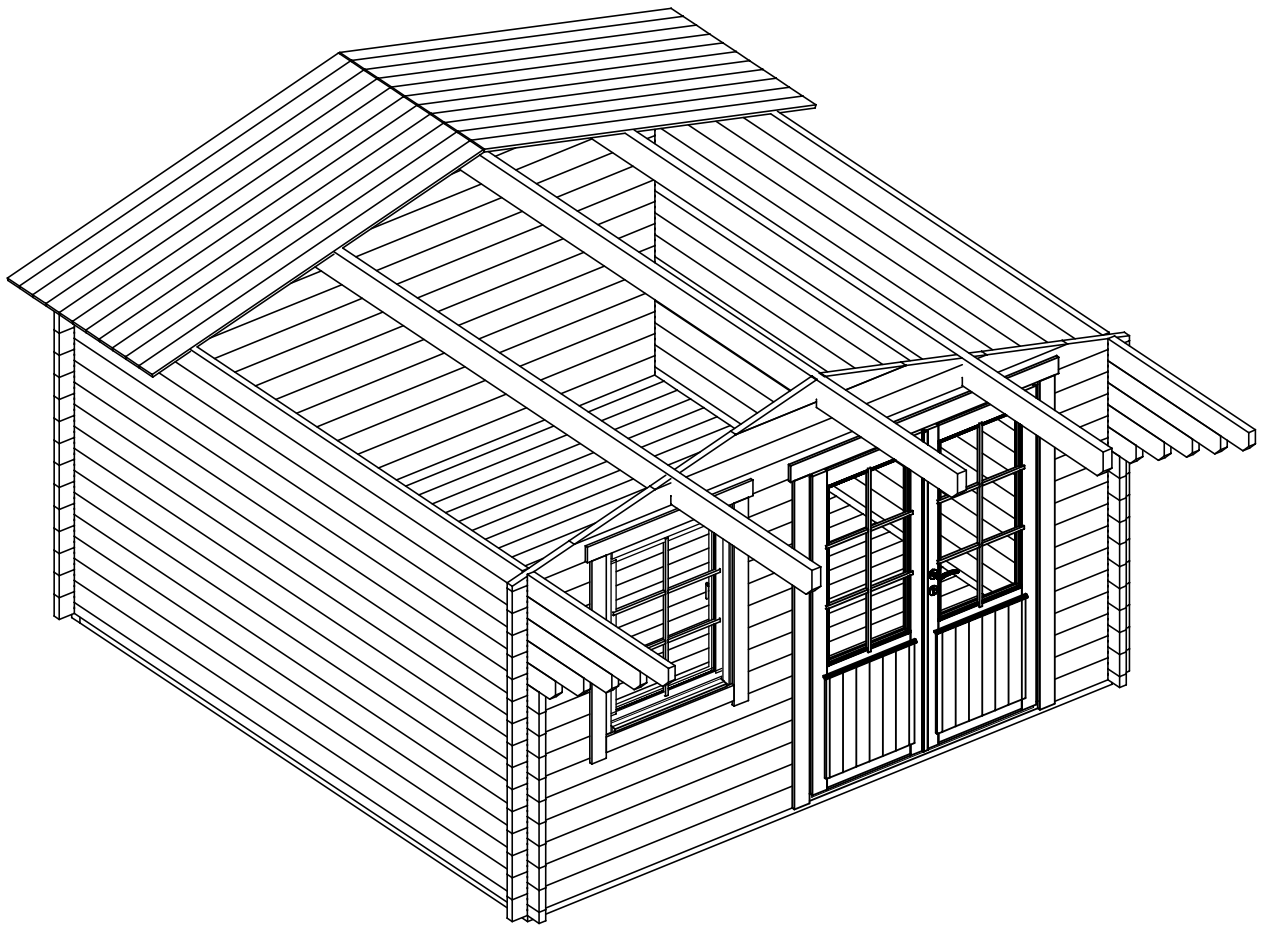

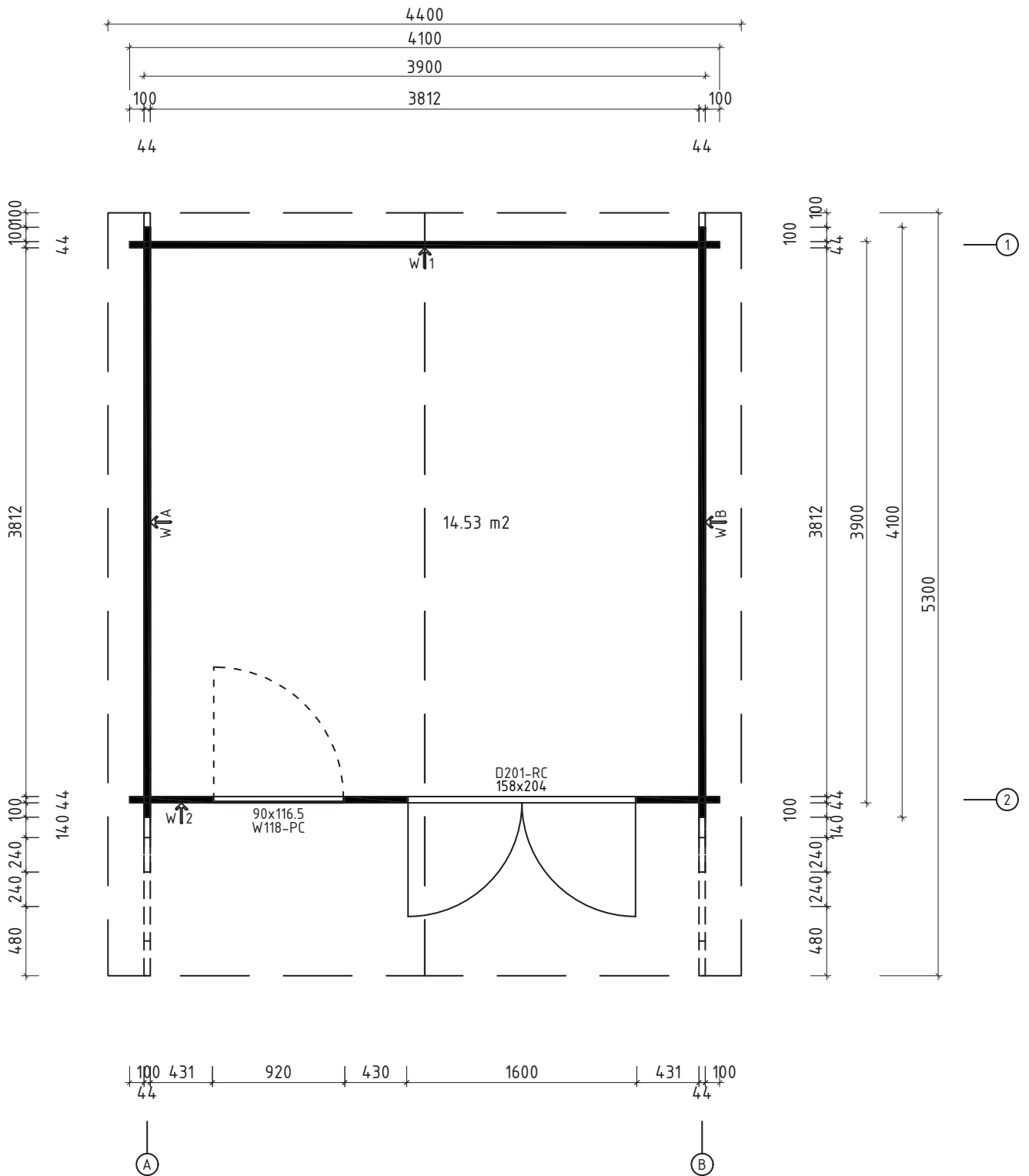





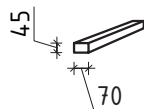
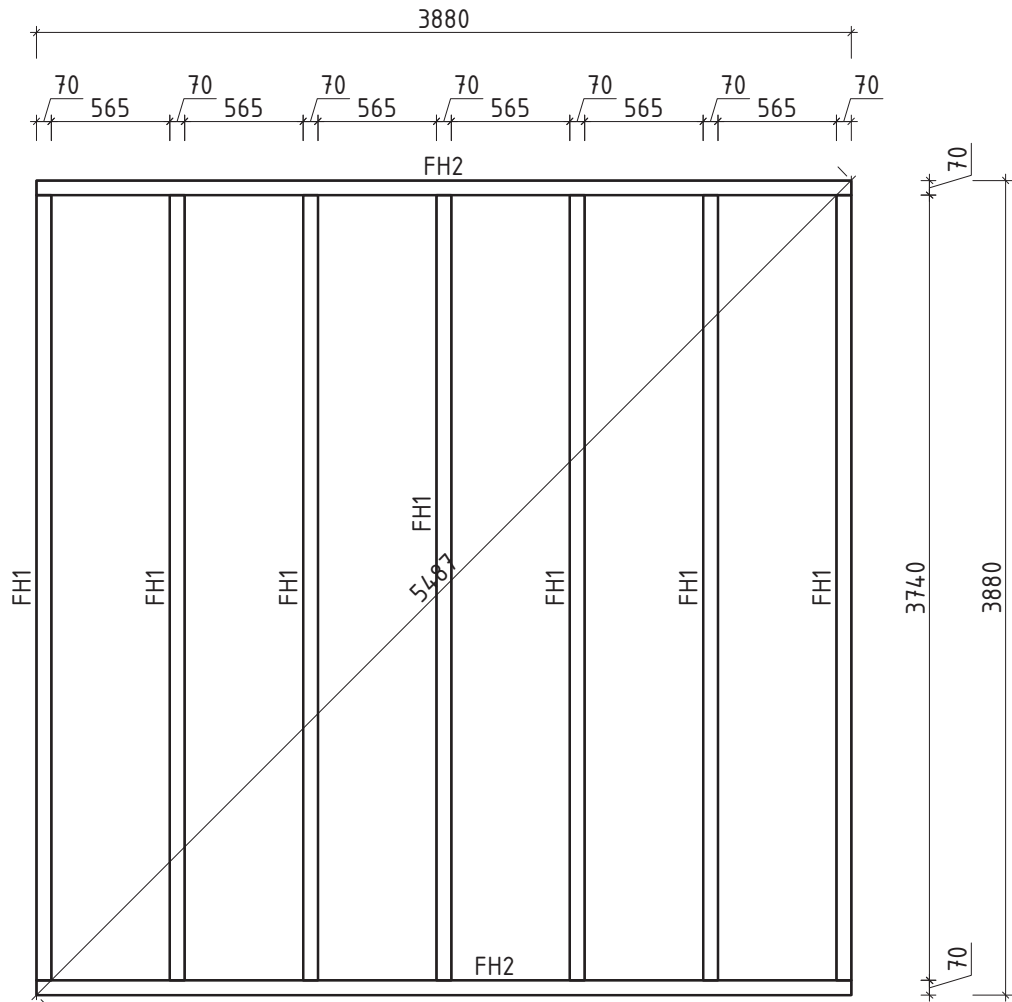



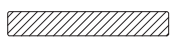













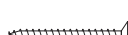

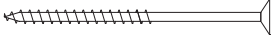









* Fenster und Türen sind mit Sprossen
Q4 – Qualitätsklasse für Fenster und Türen

Wir empfehlen als Fundament für Ihr Gartenhaus eine vollflächig festgegründete, gepflasterte oder betonierte Fläche. Wahlweise ist auch ein Punkt- oder Streifenfundament möglich.

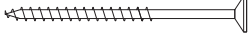

Pos	Teileliste 240480	Stck	Profil (mm)	Länge (mm)
001		1	44x135	5300
002		1	44x135	5300
003		2	44x135	4960
004		2	44x135	4720
005		2	44x135	4480
006		2	44x135	4240
007		1	44x135	4100
008		1	44x135	4100
009		2	44x68	4100
010		20	44x135	4100
011		15	44x135	4100
012		2	44x135	3276
013		2	44x135	2203
014		6	44x135	1925
015		1	44x135	1925
016		23	44x135	575
017		4	44x135	541
018		6	44x135	430
019		2	44x135	430
FH2	FUNDAMENTHÖLZER (imprägniert) 	2	70x45	3880
FH1	FUNDAMENTHÖLZER (imprägniert) 	7	70x45	3740
PF1	PFETTEN 	3	58x170	5300
	DACHBRETTER	94+1	113x18	2269
	FUSSBODENBRETTER	34+1	113x18	3807
	DECKENLEISTEN	✓	15x28	18.0lfm

Pos	Teileliste 240480	Stck	Profil (mm)	Länge (mm)
	FUSSBODENLEISTEN  ✓		18x40	17.0lfm
G02-1	GIEBELBRETTER 18x120  14.1° ✓	4	18x120	2349
G06-1	GIEBELDECKLEISTEN 18x58  ✓	4	18x58	2349
T01-1	TRAUFBRETTER 18x95  2		18x95	5300
T06-1	TRAUFELEISTEN 18x40  ✓		18x40	11.0lfm
GS	Giebelsegment  2			
SH	Schlaghölzer  3			
ML1	Metallstange  2		D10	770
NG2 550	NÄGEL 2.5x50 Dachbretter  564			
NG2 550	NÄGEL 2.5x50 Fussbodenbretter  476			
SR3 030	SCHRAUBEN 3.0x30 Deckenleisten  36			
SR3 030	SCHRAUBEN 3.0x30 Fussbodenleisten  31			
SR3 030	SCHRAUBEN 3.0x30 Traufenleisten  22			
SR3 545	SCHRAUBEN 3.5x45 Giebelbretter  20			
SR3 545	SCHRAUBEN 3.5x45 Giebeldeckleisten  20			
SR3 545	SCHRAUBEN 3.5x45 Giebelsegment  4			
SR3 545	SCHRAUBEN 3.5x45 Traufenbretter  22			
SR5 0100	SCHRAUBEN 5.0x100 Fundamenthölzer  36			
KL1	Gewindestange M8  4			2000
KL2	Gewindestange M8  4			123
KV M UT M8	Mutter M8  8			
KV S EIB M8X25	U-Scheibe M8 Ø25  8			
KV MU TJ M8	Befestigungsmutter M8  4			
	Achtung! Die Giebelbohlen können teilweise schon vormontiert sein! Bitte beachten - diese erscheinen nicht ganz so wie in der Teileliste beschrieben.			
	✓ - bitte selber anpassen (falls nötig)!			

Pos	Teileliste 240480	Stck	Profil (mm)	Länge (mm)	
	<p>TÜR 1580x2040 D4-D44R-56C-15802040</p> <p>Q4 D201-RC 1580</p>  <div style="border: 1px solid black; padding: 5px; width: fit-content;"> <p>Right handed / DIN rechts / paremakäeline</p> <p>Clear opening/ durchgangsmaß/ ava suurus 1452x1932mm</p> <p>double-pane clear float glass ISO Glas 2-fach 2x klaaspakett, kirkas klaas</p> </div>	1			
PROSS H41-2	Q4-1 Muntins - Sprossen - Prossid horizontal 18x18		4	18x18	575
PRO SS V42-2	Q4-2 Muntins - Sprossen - Prossid vertical 18x18		2	18x18	1125
PL3-4	Trims - Rahmenleisten - Piirdeliistud 18x95	 ✓	4	18x95	2020
PL3-5	Trims - Rahmenleisten - Piirdeliistud 18x95	 ✓	2	18x95	1780
SR30 20-01	3.0x20 Locking plate - Schließblech - Riivi vastus 02 Q4		2		
SR30 22-01	3.0x20ÜP Muntins - Sprossen - Prossid		12		
SR35 47-01	3.5x45 C3 Trims - Rahmleisten - Piirdeliistud		24		
SR50 90-01	5.0x90 Door frames - Türrahmen - Ukselengid		8		
RV02	Locking plate - Schließblech - Riivi vastus 02 Q4		1		
LS-Q4	Q4 Cylinder lock - Zylinderschloss - Lukusüdamik		1		
UL-Q4	Q4 Door handle - Türgriff - Ukselink		1		

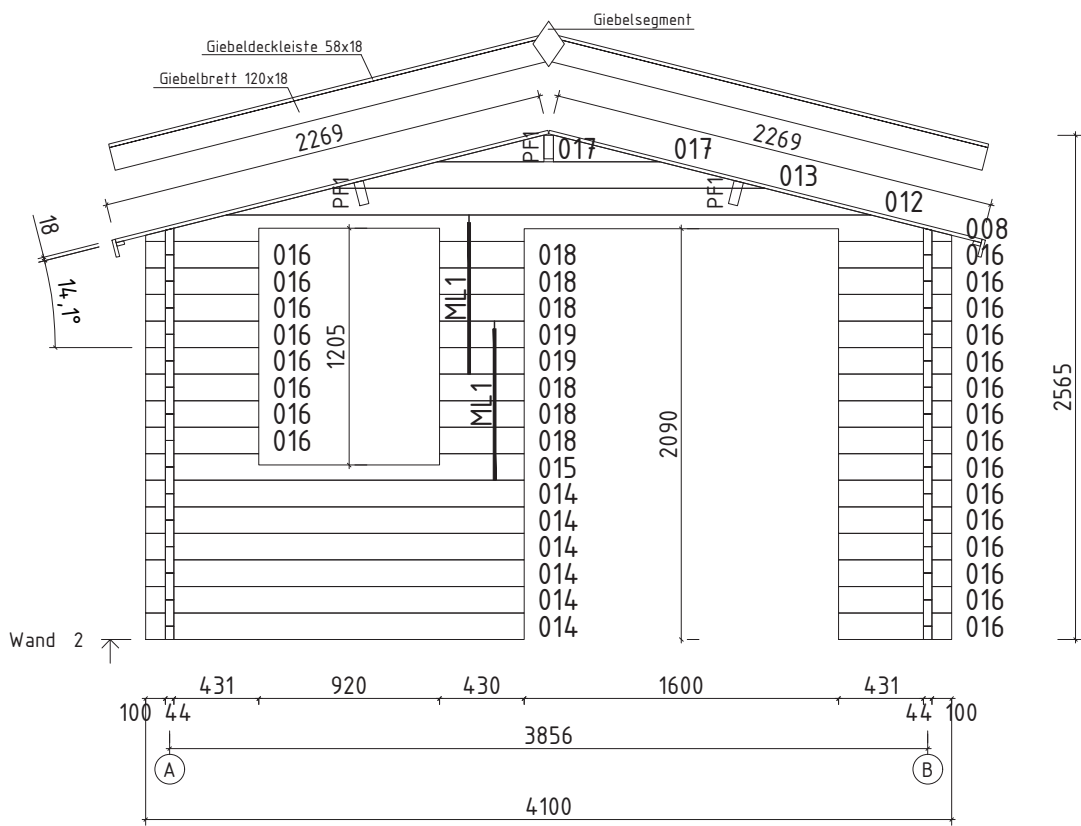

Veeplekk / Window sill / Fensterbank

Q4

