

Technische Daten

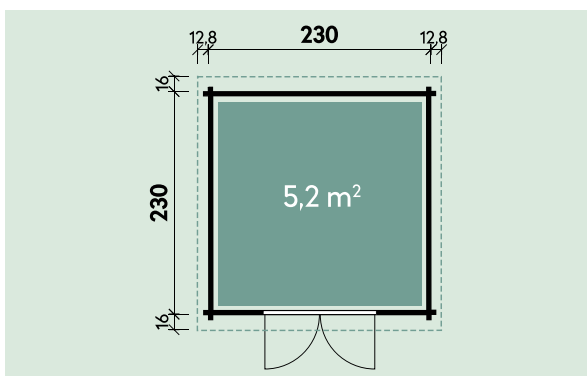

Artikelnummer:

611 110



Kontrolliert durch:

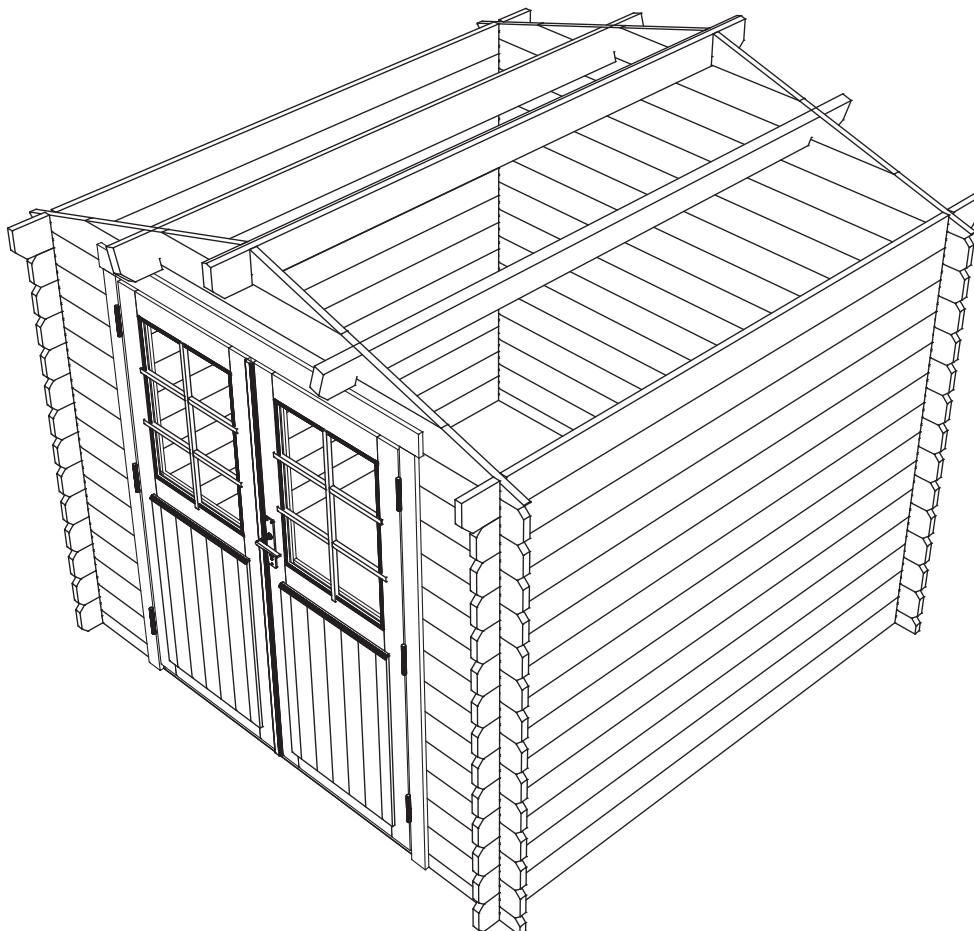

H = 1.700 m
TOTAL: 5.04 m²

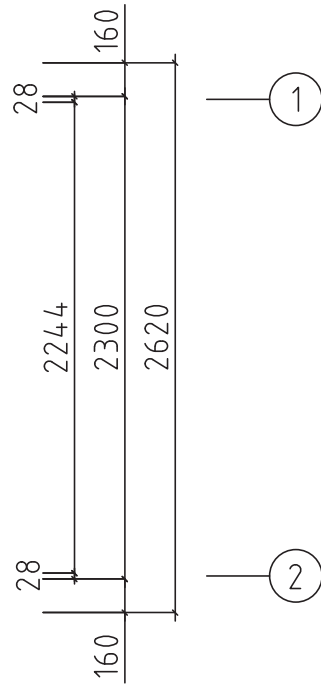
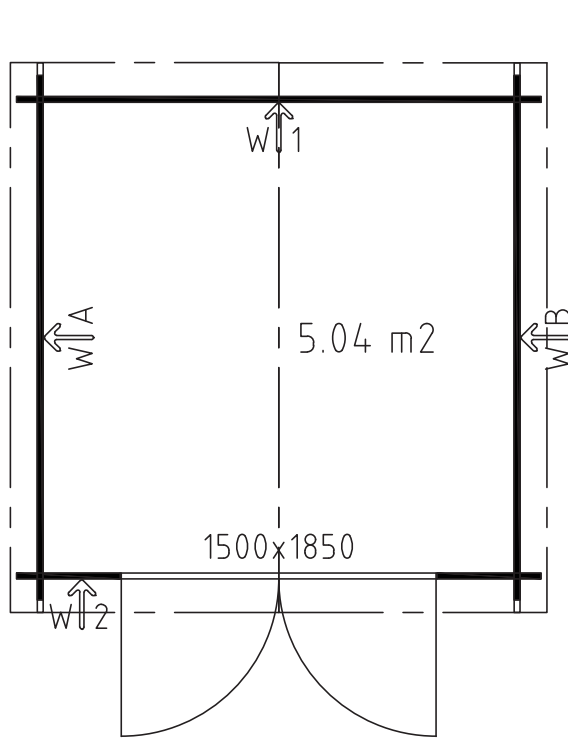
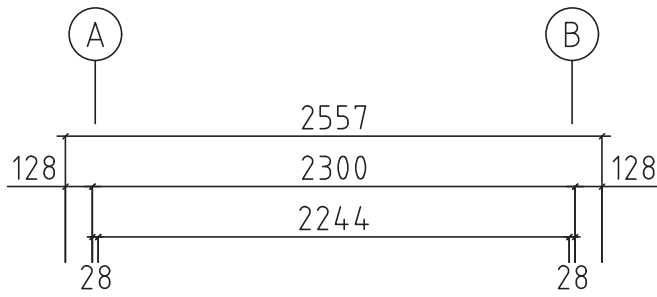

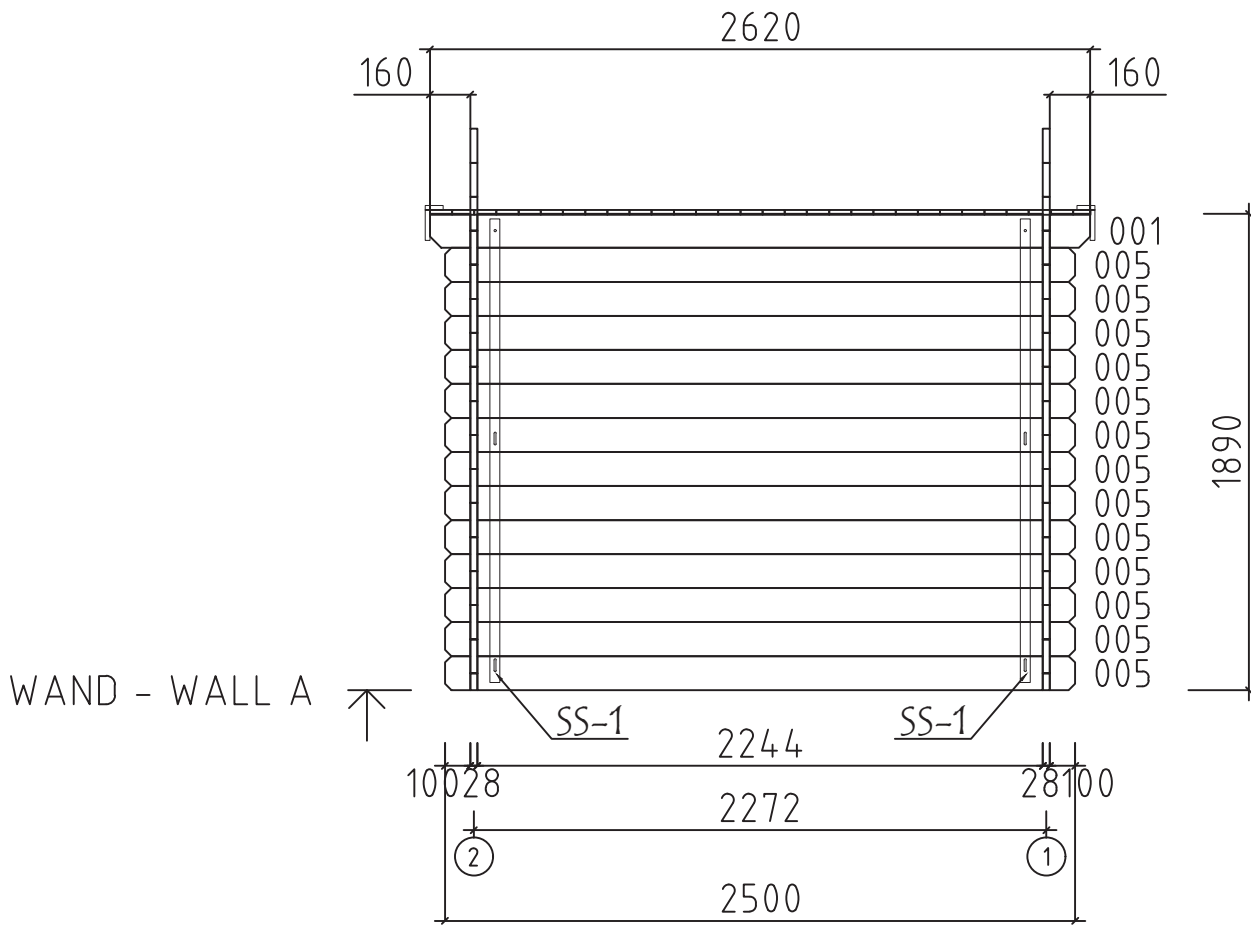

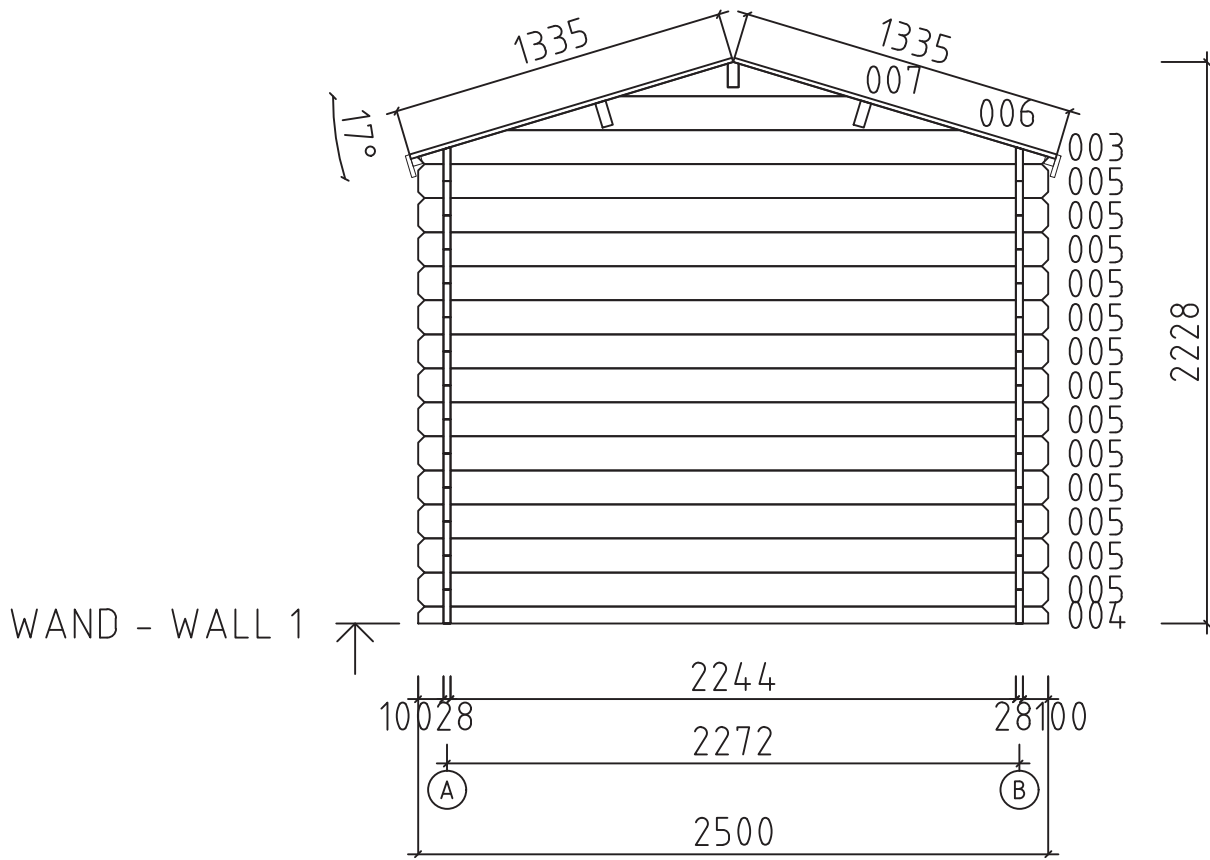

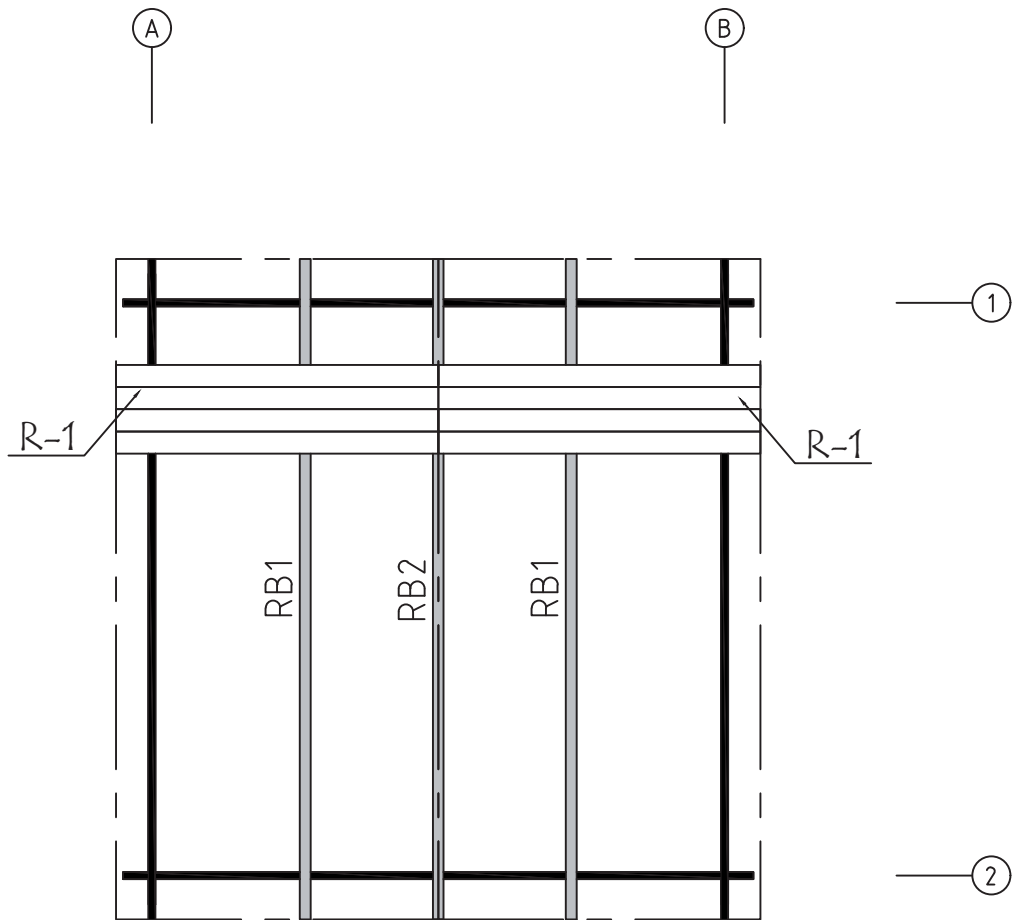

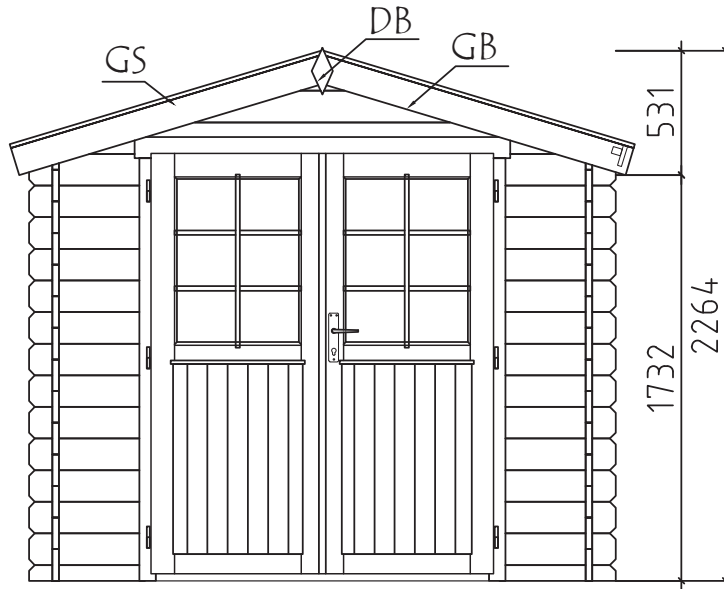
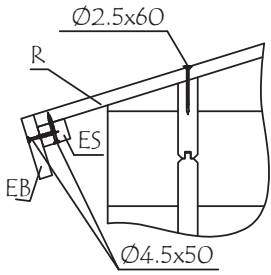





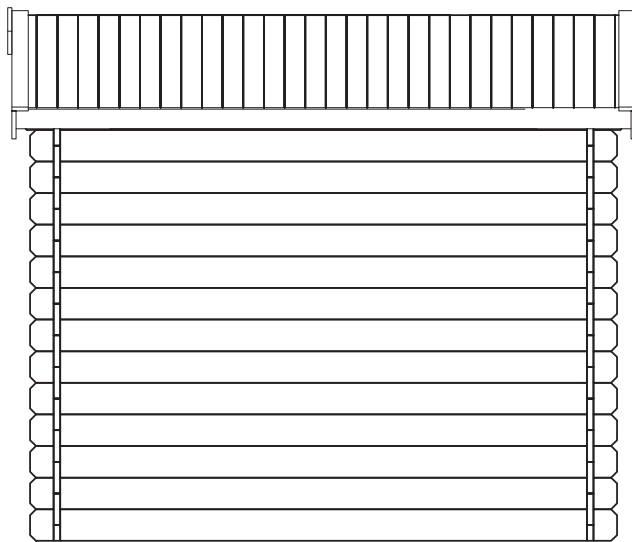
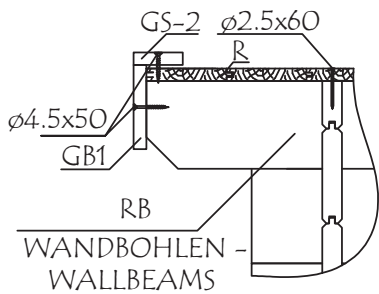





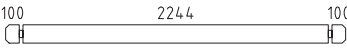
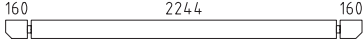
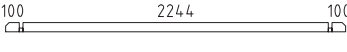
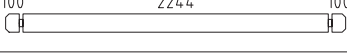

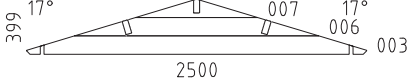
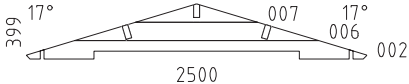

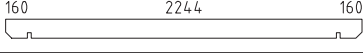
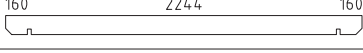
VORDERANSICHT-FRONT VIEW

SCALE: NOT TO SCALE



SEITENANSICHT (RECHTS) - SIDE VIEW (RIGHT)

SCALE: NOT TO SCALE

Pos	Bestimmung-Specification 2834280	Stck. Pcs.	Profil Profile (mm)	Länge Length (mm)
EX1	ERZATZBOHLE - SPARE BEAM 	1	28x135	2500
001		2	28x135	2620
004		1	28x68	2500
005		39	28x135	2500
008		26	28x135	495
009		2	28x68	495
W1-1		1	28x399	2500
W2-1		1	28x399	2500
SH	SCHLAGHOLZ - HAMMER BLOCK 28 MM 	2	28x135	300
RB1	DACHBALKEN - ROOF BEAM 	2	43x140	2620
RB2	DACHBALKEN - ROOF BEAM 	1	43x140	2620
R-1	DACHBRETT - ROOFBOARD 88mm or-oder 114mm 	60+2 46+2	88x18 114x18	1340
GB1-1	GIEBELLEISTE - GABLE MOULDING 	4	18x120	1385
EB2-1	TRAUFENBRETTER - EAVES BOARD 	1	18x90	2620
ES-1	TRAUFENLEISTE - EAVES STRIPS 	1	30x40	2620
GS-1	GIEBELDECKLEISTE - GABLE COVER STRIPS 	4	18x70	1385
DB	GIEBELSEGMENT - GABLE DIAMOND 	2	18x90	200
SS-1	STURMLEISTE - STORM PROTECTION 	4	18x35	1840
HS2	SCHRAUBEN FÜR STURMLEISTE - SCREWS FOR STORM PROTECTION / SS 	12	Ø6x40	
KL	DICHTSCHEIBE FÜR STURMLEISTE - WASHER FOR STORM PROTECTION / SS 	12	M6x18	
HS11	SCHRAUBEN FÜR GIEBELSEGMENT - SCREWS FOR GABLE DIAMOND / DB 	4	Ø3.5x35	

