

Technische Daten: Art.-Nr.: 845110

Wandaußenmaß: 450 x 330 cm

Bohlenstärke: 44 mm



Cordoba 44-A Modern

Kontrolliert durch:

Empty box for signature or name.

Achtung: Alle angegebenen Maße sind ca.-Maße!

845110



Cordoba 44-A Modern

Kontrolliert durch:

Achtung: Alle angegebenen Maße sind ca.-Maße!

3D-Darstellung und Grundriss 845110

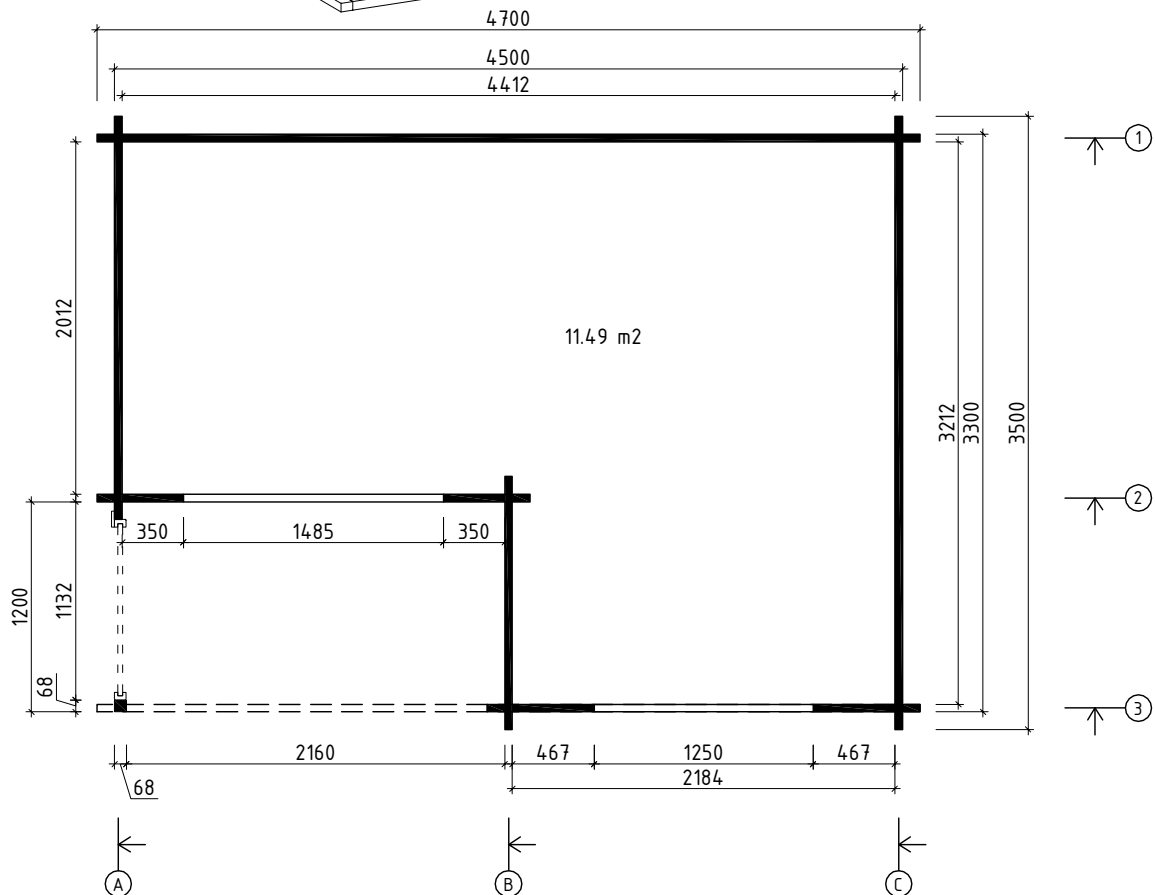
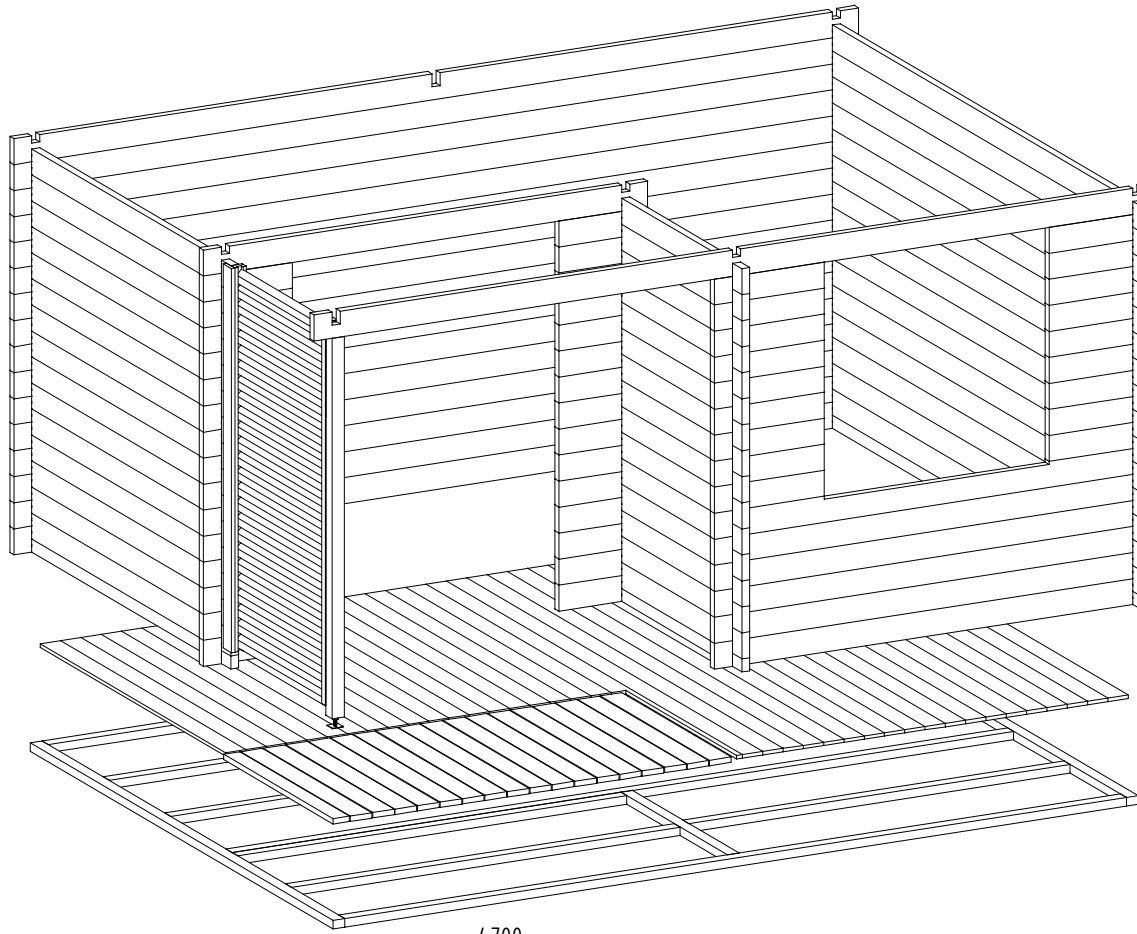





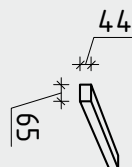
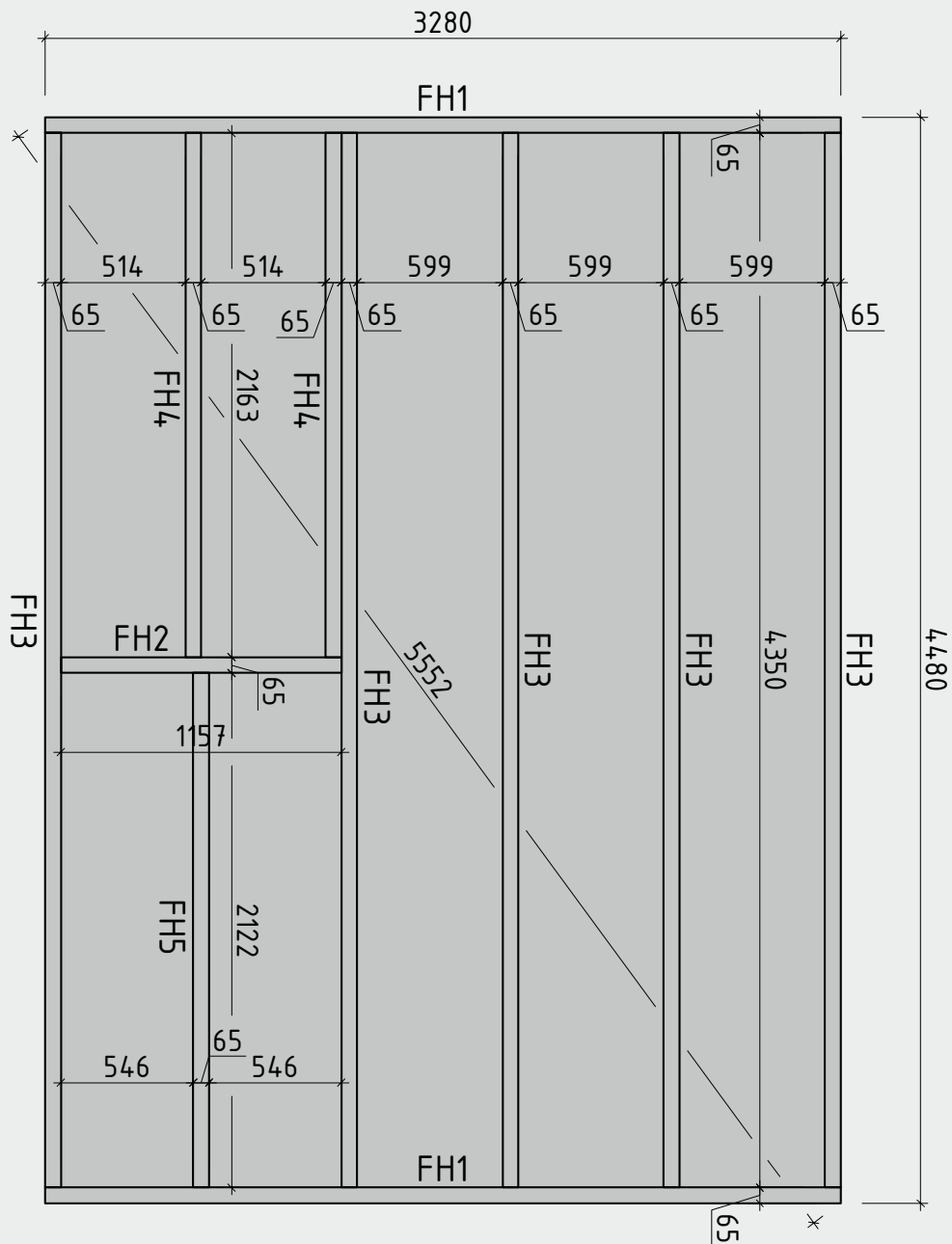





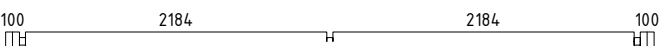
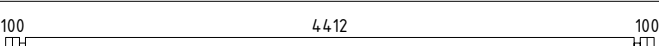

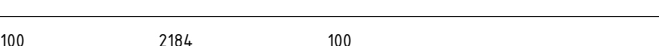
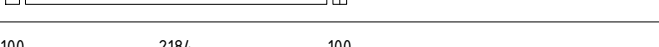
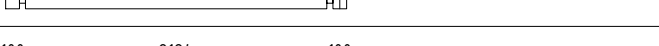

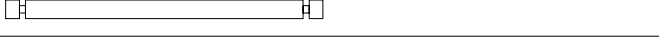
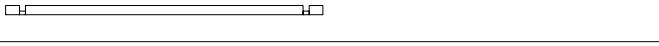

Lagerholzplan und Fundamentplan 845110

Wir empfehlen als Fundament für Ihr Gartenhaus eine vollflächig, festgegründete gepflasterte oder betonierte Fläche.
Wahlweise ist auch ein Punkt- oder Streifenfundament möglich.

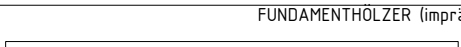

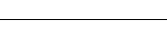

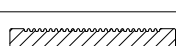







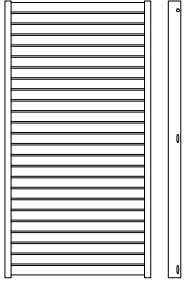

Teileliste 1

Korpus für 845110

| Pos | | Stck | Profil (mm) | Länge (mm) |
|-------|--|------|-------------|------------|
| 001 |  | 1 | 44x135 | 4700 |
| 002 |  | 1 | 44x135 | 4700 |
| 003 |  | 15 | 44x135 | 4700 |
| 004 |  | 15 | 44x135 | 3500 |
| 005 |  | 1 | 44x68 | 3500 |
| 006 |  | 1 | 44x135 | 2472 |
| 007 |  | 5 | 44x135 | 2472 |
| 008 |  | 1 | 44x135 | 2472 |
| 009 |  | 15 | 44x135 | 2300 |
| 010 |  | 1 | 44x68 | 2300 |
| 011 |  | 15 | 44x135 | 1444 |
| 012 |  | 1 | 44x68 | 1444 |
| 013 |  | 9 | 44x135 | 611 |
| 014 |  | 9 | 44x135 | 611 |
| 015 |  | 30 | 44x135 | 493 |
| FH3 | FUNDAMENTHÖLZER (imprägniert)  | 5 | 65x44 | 4350 |
| FH1 | FUNDAMENTHÖLZER (imprägniert)  | 2 | 65x44 | 3280 |
| FH4 | FUNDAMENTHÖLZER (imprägniert)  | 2 | 65x44 | 2163 |
| FH5 | FUNDAMENTHÖLZER (imprägniert)  | 1 | 65x44 | 2122 |
| FH2 | FUNDAMENTHÖLZER (imprägniert)  | 1 | 65x44 | 1157 |
| | FUSSBODENBRETTER  | 20+1 | 113x18 | 3205 |
| | FUSSBODENBRETTER  | 19 | 113x18 | 2005 |
| | TERRASSENBRETTER (imprägniert)  | 18+1 | 120x28 | 1190 |
| | FUSSBODENLEISTE  ✓ | | 18x40 | 16,0 lfm |
| SP1-1 | STÜTZPFOSTEN 68x68  ✓ | 1 | 68x68 | 2095 |

Teileliste 2

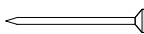
Korpus für 845110

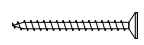
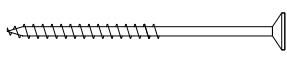
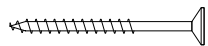
| Pos | | | Stck. | Profil (mm) | Länge (mm) |
|------|--|--|-------|-------------|------------|
| | GITTERWAND ELEMENT |  | 1 | 105x1994 | |
| SH | Schlaghölzer |  | 3 | | |
| SS02 | Schlossschrauben M8x70 Mutter U-Scheibe (für Gitterwand) |  | 3 | M8 | |
| VP1 | Verstellbare Pfostenstütze M10 |  | 1 | M10 | |
| KL1 | Gewindestange M8 |  | 3 | M8 | 2000 |
| KL2 | Gewindestange M8 |  | ✓ 1 | M8 | 460 |
| KL3 | Gewindestange M8 |  | ✓ 2 | M8 | 325 |
| KL4 | Gewindestange M8 |  | ✓ 1 | M8 | 430 |
| | Mutter M8 U-Scheibe Ø25 |  | 8 | M8 | |
| | Befestigungsmutter M8 |  | 3 | M8 | |
| NG1 | NÄGEL 2.5x50 Dachbretter Fussbodenbretter |  | 390 | | |
| NG2 | NÄGEL 2.5x60 Terrassenbretter |  | 108 | | |
| SR01 | SCHRAUBEN 3.0x30 Fussbodenleisten |  | 30 | | |
| SR03 | SCHRAUBEN 3.5x45 Gitterwand |  | 6 | | |
| SR11 | SCHRAUBEN 5.0x100 Fundamenthölzer |  | 28 | | |
| SR10 | SCHRAUBEN 5.0x70 Gitterwand |  | 4 | | |
| | | | | | |
| | | | | | |
| | | | | | |
| | | | | | |
| | | | | | |
| | | | | | |
| | | | | | |
| | ✓ - bitte selber anpassen (falls nötig)! | | | | |

Teileliste 3

Korpus für 845110

Montageanleitung für Gitterwand

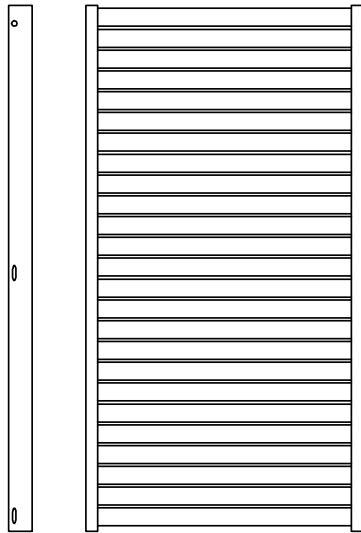

Schrauben 3.5*45mm

6 Stck.



Schrauben 5x70mm

4 Stck.

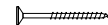

Schlossschrauben M8x70
Mutter U-Scheibe

3 Stck.

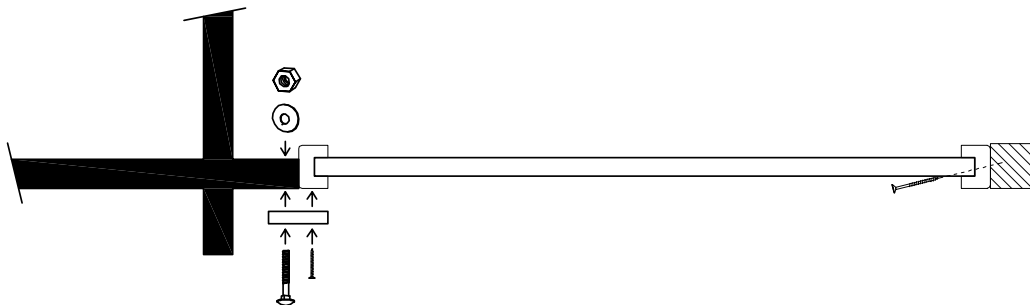
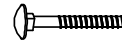

Spiegelverkehrt



Wandplan 1 und 2

Korpus für 845110

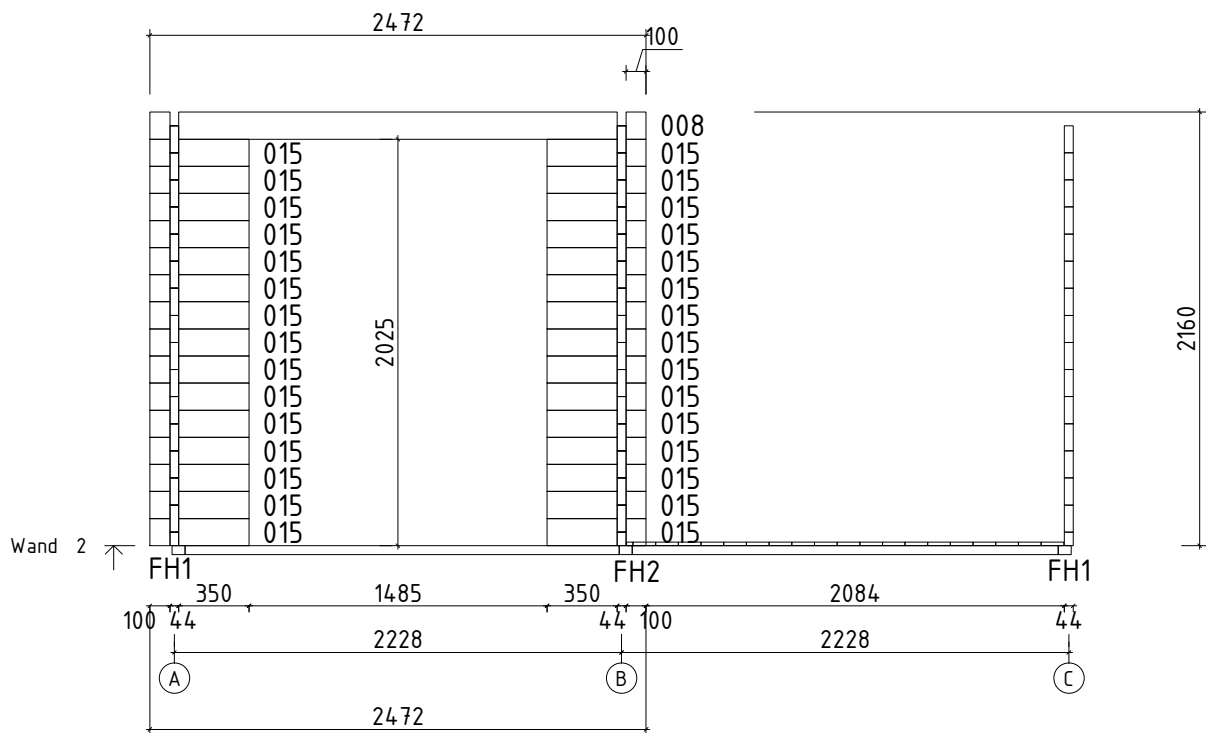
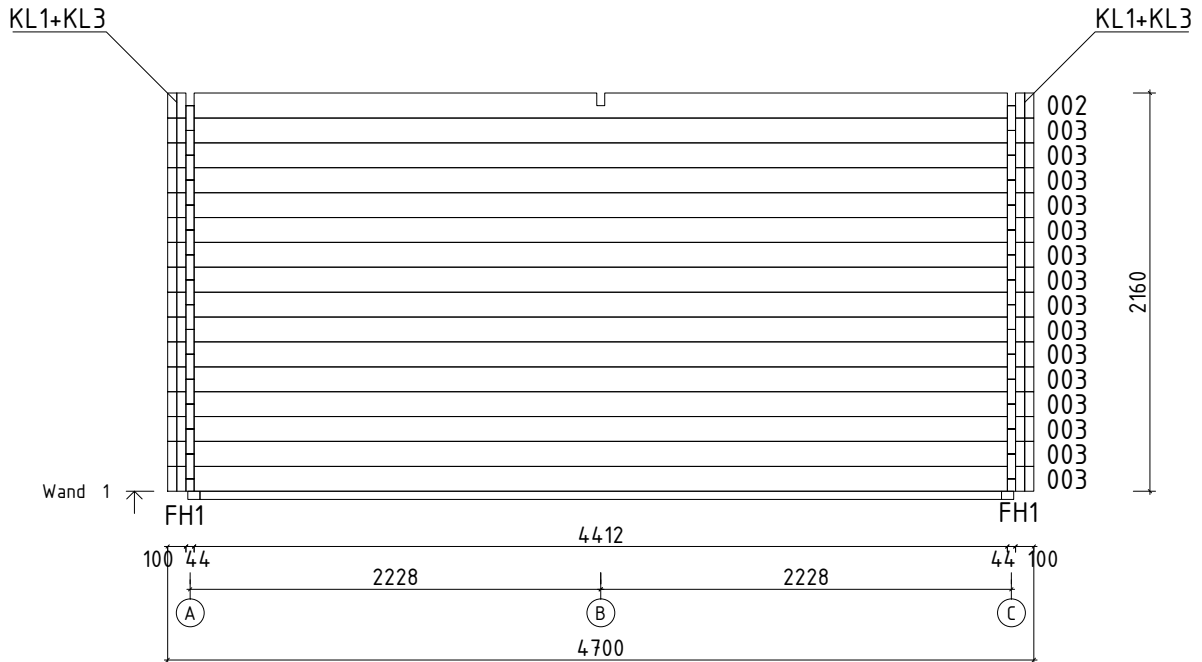

Wandplan 3 Korpus für 845110

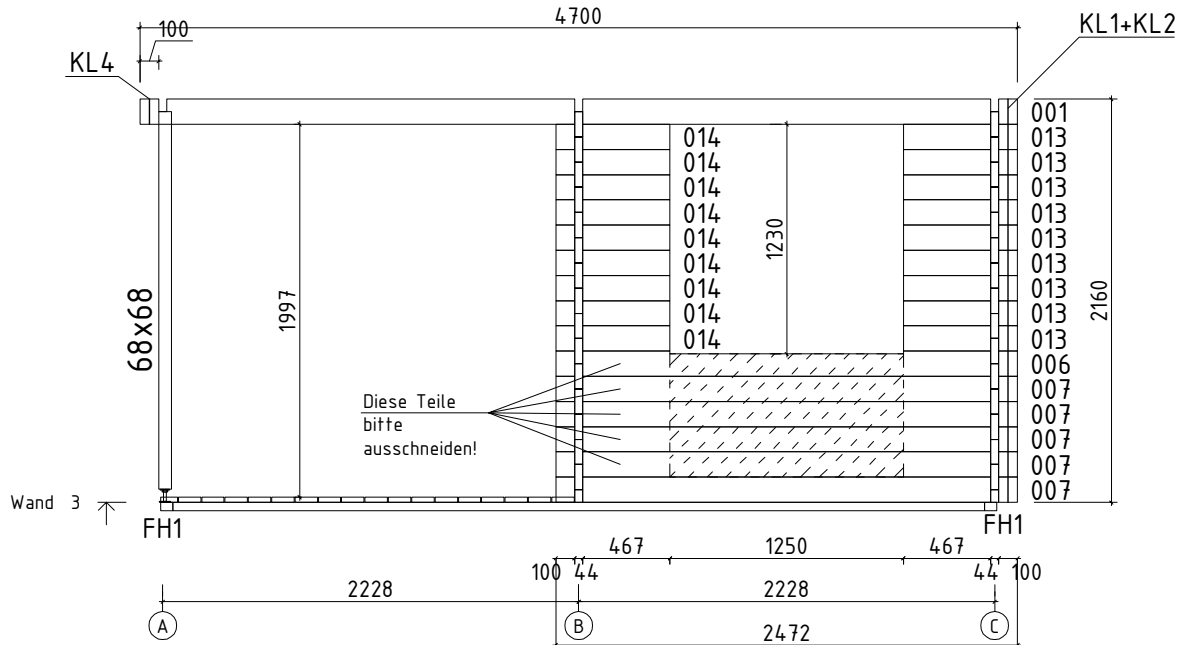

Wenn Sie sich für das Haus Cordoba/Malaga A MODERN entschieden haben, müssen Sie die Fensteröffnung in Wand 3 vergrößern. Die Bohlen 006 und die oberen 4x 007 müssen ausgeschnitten werden, wie in der Zeichnung gezeigt wird. Die Bohlen sollen aussehen wie pos 013 und 014.

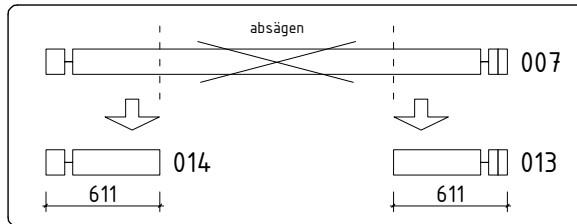

Wandplan A und B

Korpus für 845110

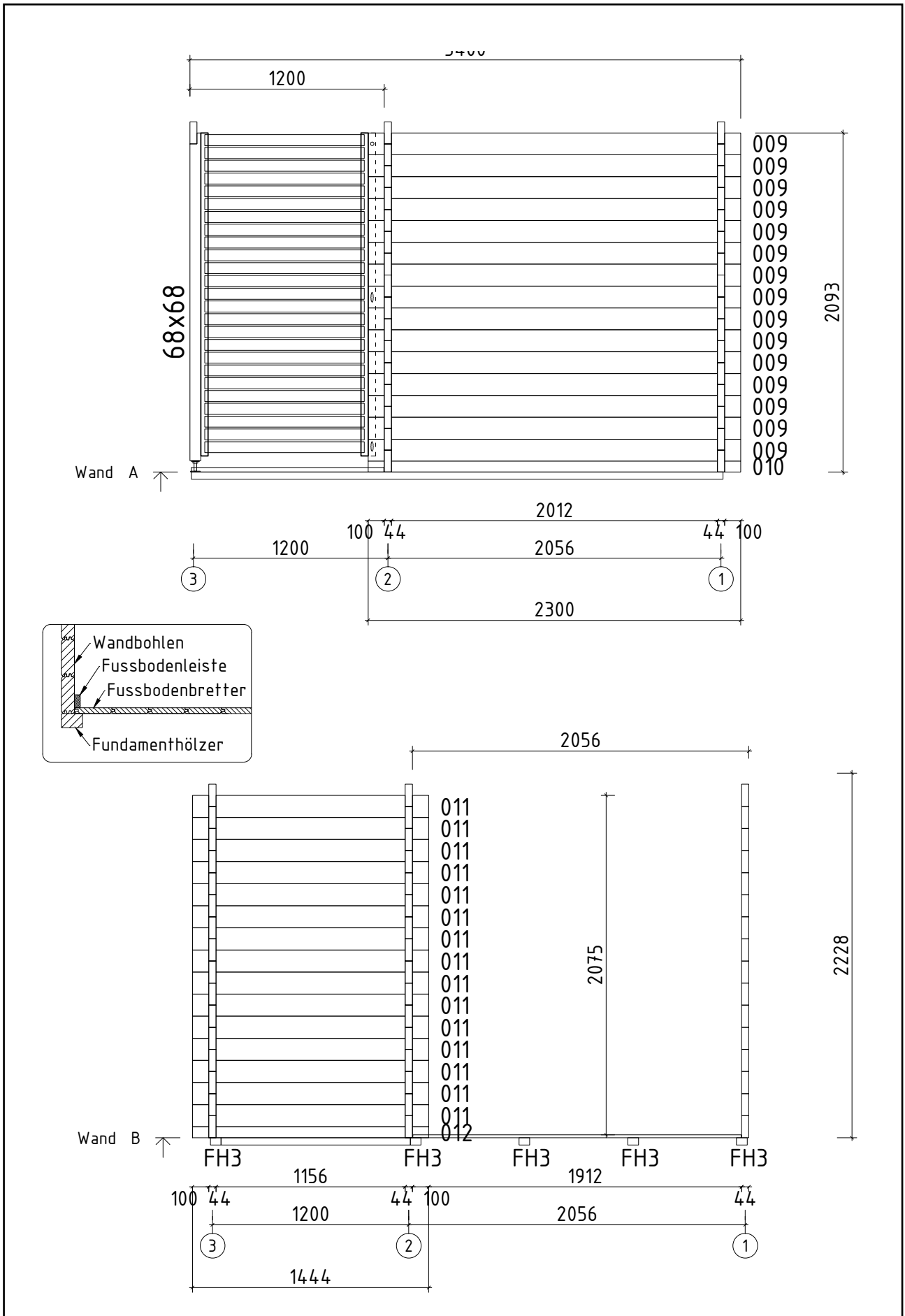

Wandplan C

Korpus für 845110

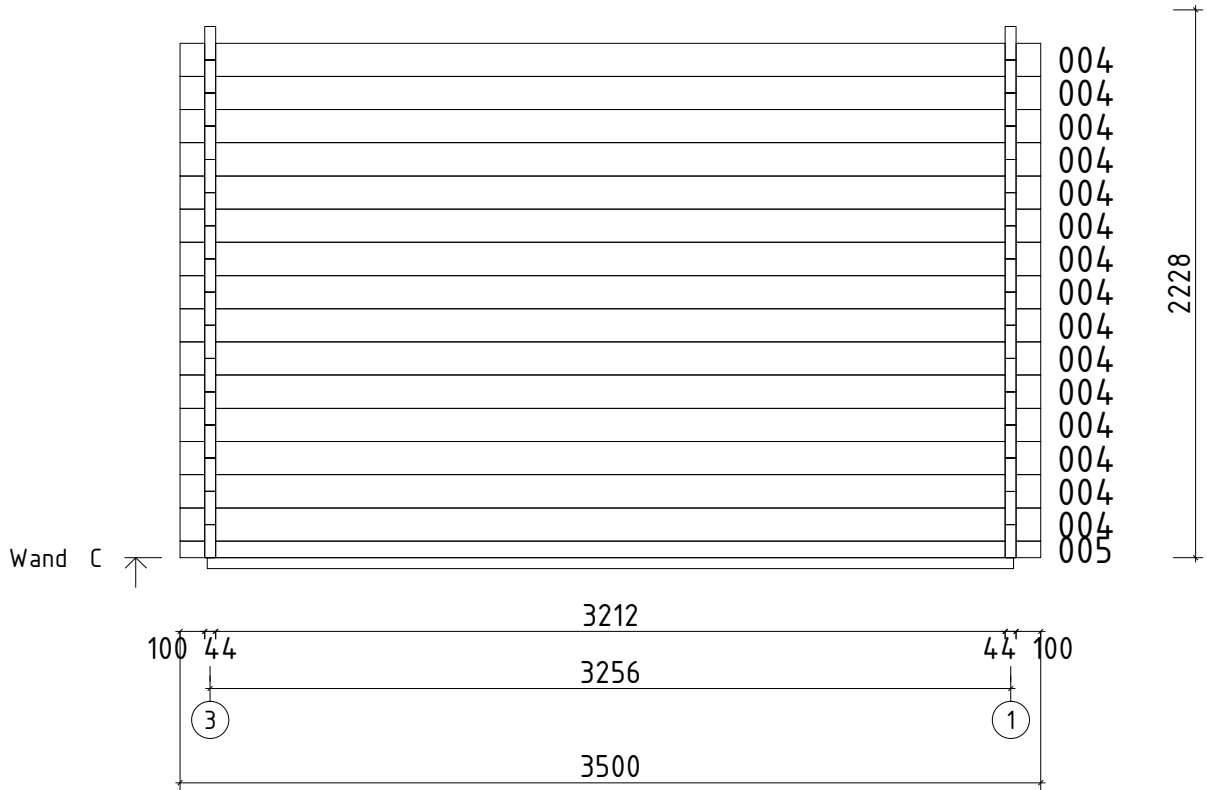

Flachdach für 845110



Cordoba 44-A Modern

Kontrolliert durch:

Achtung: Alle angegebenen Maße sind ca.-Maße!

3D-Darstellung und Grundriss Flachdach für 845110

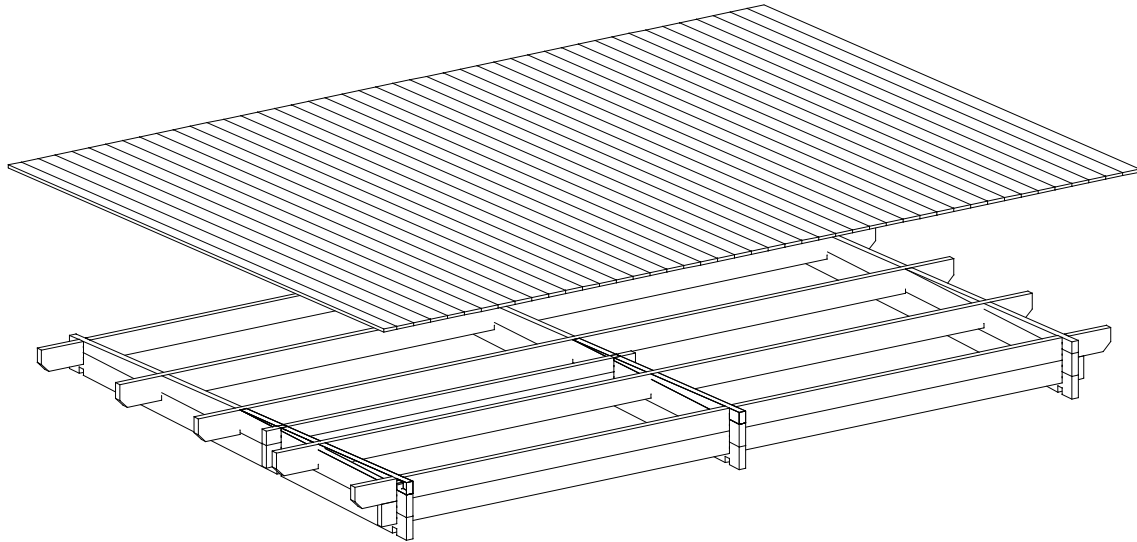

Teileliste 1

Flachdach für 845110

| Pos | | Stck. | Profil (mm) | Länge (mm) |
|------|--|-------|-------------|------------|
| 001 | | 2 | 44x133 | 5060 |
| 002 | | 1 | 44x135 | 4700 |
| 003 | | 1 | 44x135 | 3500 |
| 004 | | 2 | 44x135 | 3500 |
| 005 | | 1 | 44x135 | 3500 |
| 006 | | 2 | 44x135 | 3500 |
| 007 | | 1 | 44x83 | 2472 |
| 008 | | 1 | 44x135 | 2472 |
| 009 | | 2 | 44x72 | 1728 |
| 010 | | 1 | 44x72 | 1728 |
| DB1 | | 3 | 44x145 | 5060 |
| | DACHBRETTER | 45+1 | 113x18 | 3905 |
| G1-1 | GIEBELBRETTER 120X18 | 2 | 120x18 | 3925 |
| G6-1 | GIEBELDECKLEISTE 40X18 | ✓ 2 | 40x18 | 3923 |
| T1-1 | TRAUFBRETTER 120X18 | 1 | 120x18 | 5096 |
| T2-1 | TRAUFBRETTER 90X18 | 1 | 90x18 | 5060 |
| T4-1 | TRAUFENLEISTE 40x18 | ✓ | 40x18 | 11,0 lfm |
| T6-1 | TRAUFENDECKLEISTE 40x18 | 2 | 40x18 | 2548 |
| SH | Schlaghölzer | 3 | | |
| NG3 | DACHPAPPNÄGEL 2.0x18 | 400 | | |
| NG1 | NÄGEL 2.5x50 Dachbretter | 450 | | |
| SR01 | SCHRAUBEN 3.0x30 Giebeldeckleisten Traufenleisten, Traufendeckleisten | 51 | | |
| SR03 | SCHRAUBEN 3.5x45 Giebelbretter, Traufenbretter | 40 | | |
| | DACHPAPPE | ✓ | 5,1m-5st. | 26,0 lfm |
| | ✓ - bitte selber anpassen (falls nötig!) | | | |

Wandplan 1 und 2 Flachdach für 845110

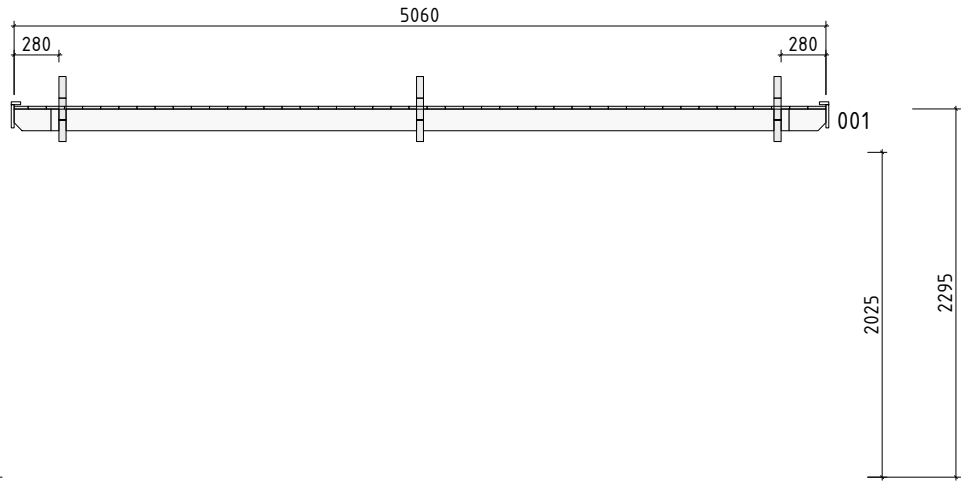
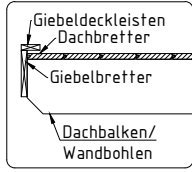

Wand 1 ↗

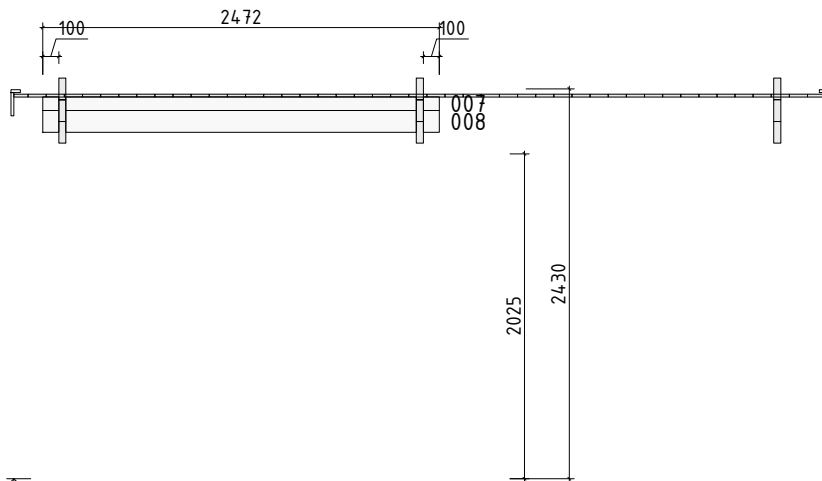
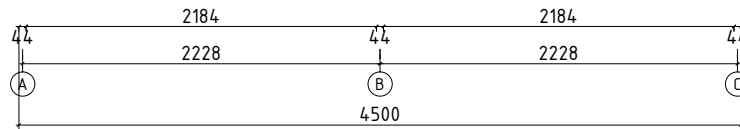

Wand 2 ↘

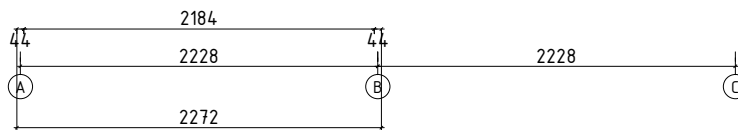

Wandplan 3

Flachdach für 845110

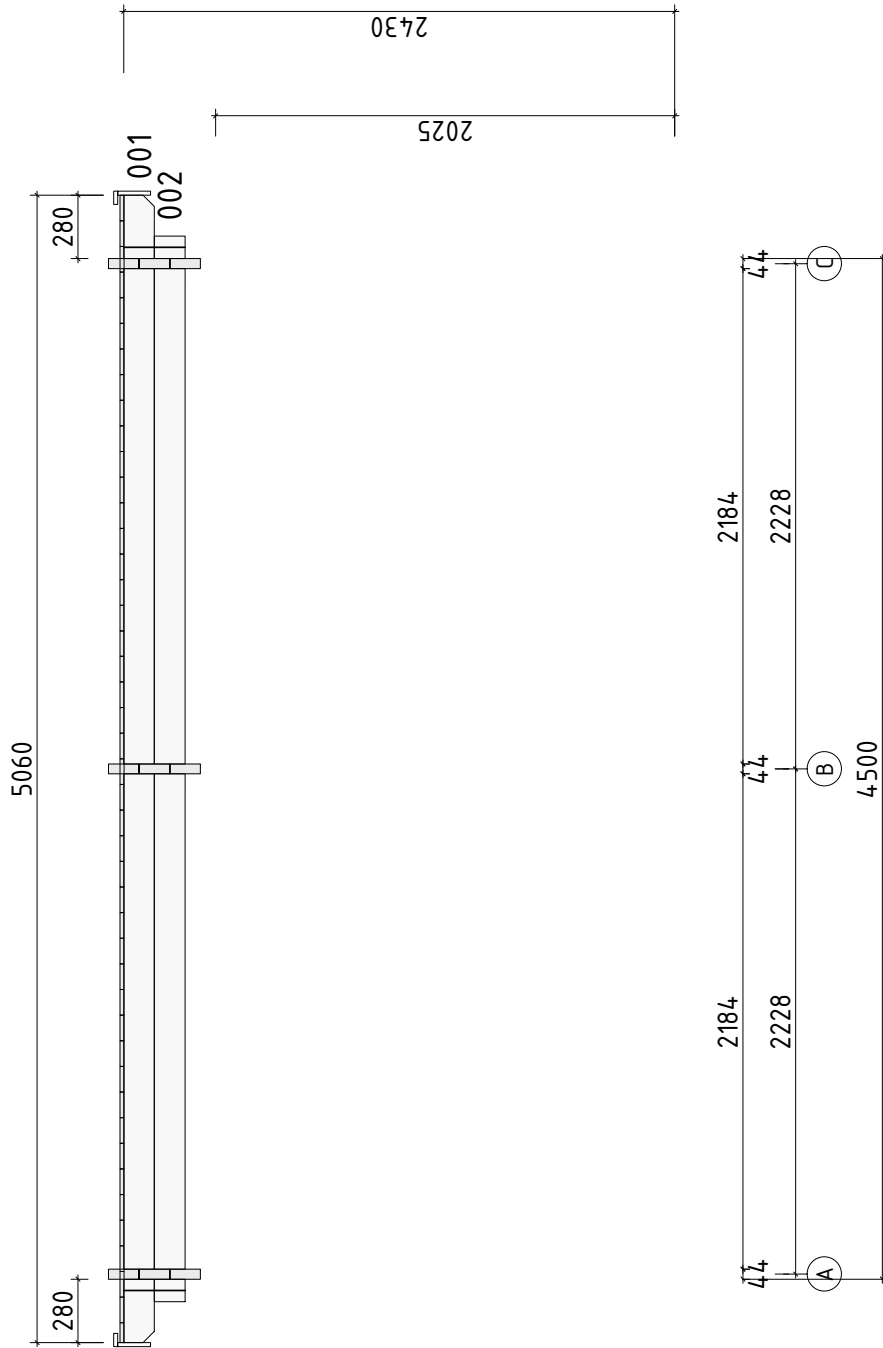

Wand 3 ↗

Wandplan A Flachdach für 845110

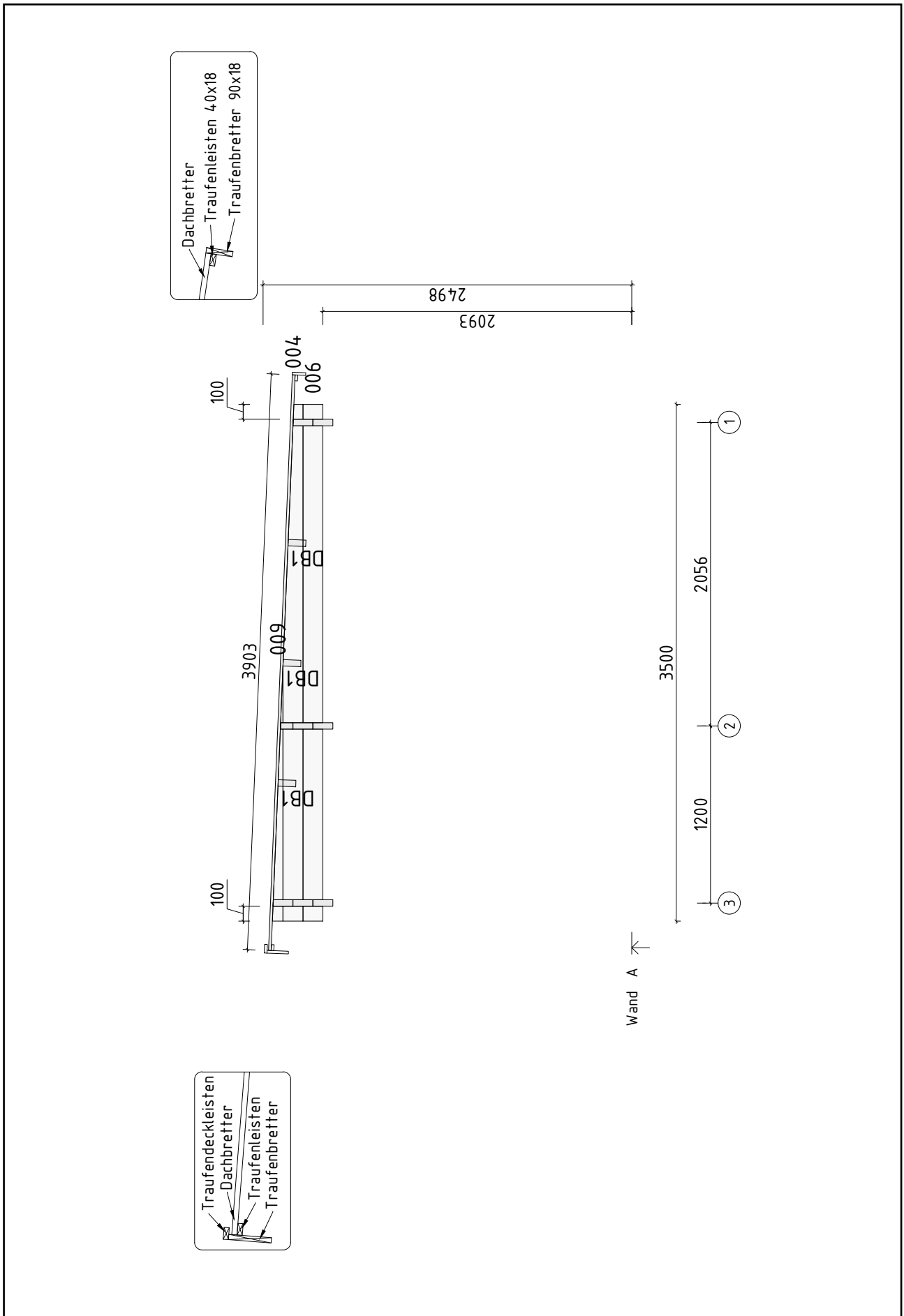

Wandplan B und C Flachdach für 845110

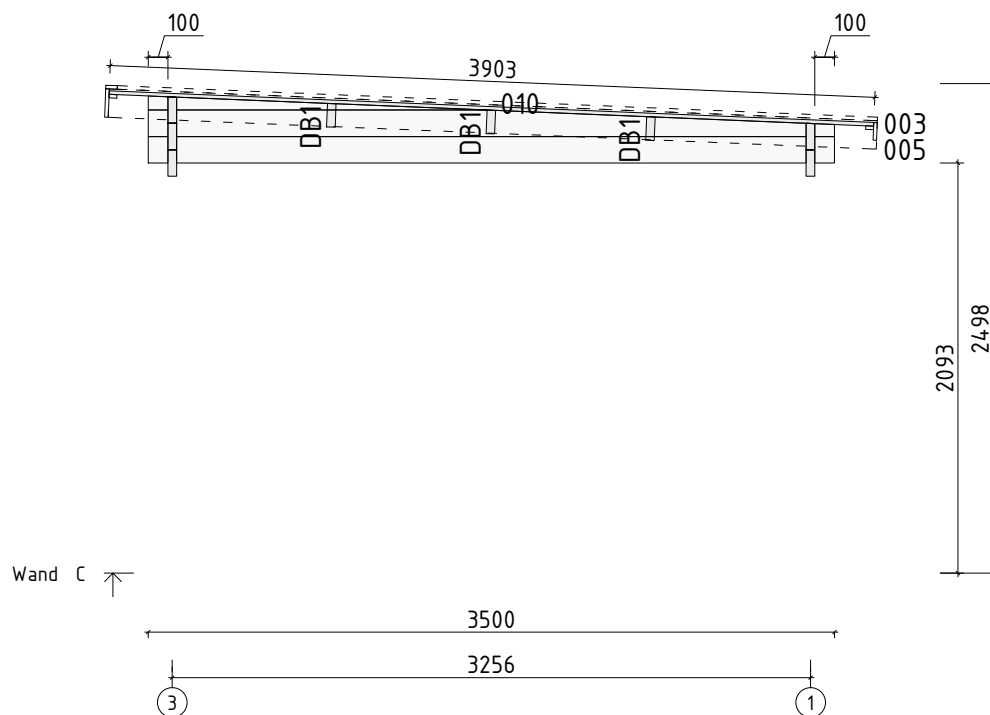
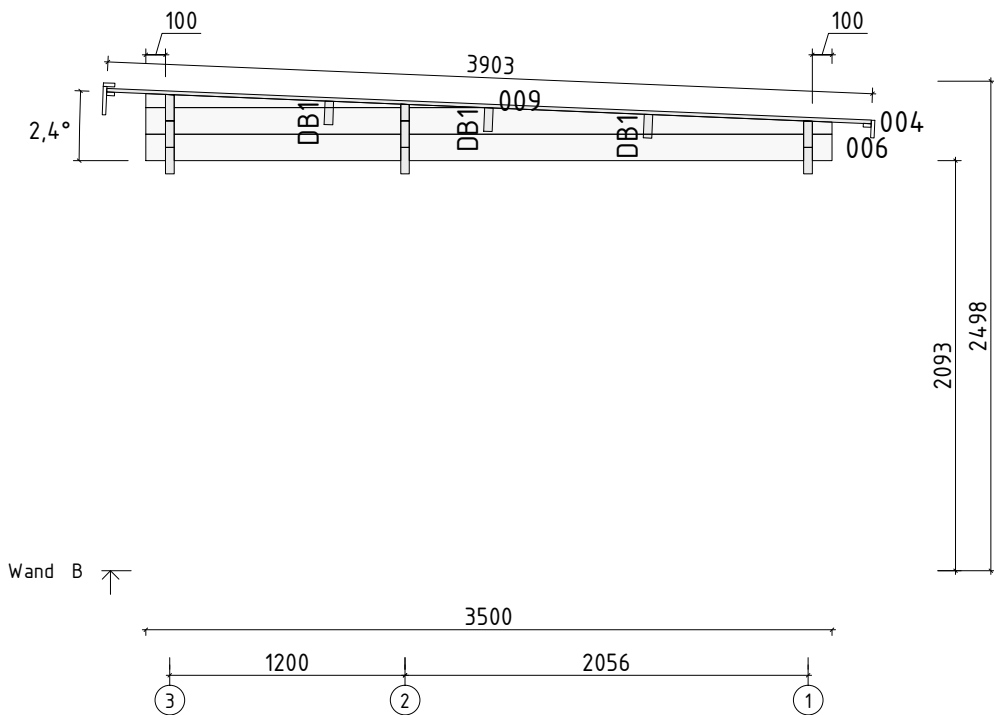

Fenster und Türen 845110



Cordoba 44-A Modern



Kontrolliert durch:

Achtung: Alle angegebenen Maße sind ca.-Maße!

Teileliste 1

Fenster und Türen 845110

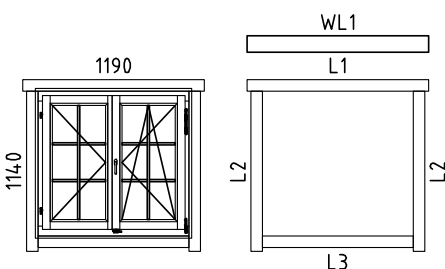
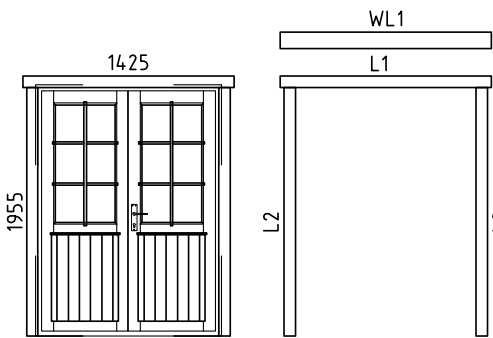
Spezifikation für Fenster und Türen
Modell Cordoba A - Set KLASSIK

| | | | | |
|------|--|--|----|--|
| | <p>FENSTER 1190x1140</p>  <p>A68-7</p> <p>L1 18x90 L=1430mm 2 Stck. L2 18x90 L=1260mm 4 Stck. L3 18x90 L=1190mm 2 Stck. ✓ WL1 36x129 L=1430mm 1 Stck.</p> <p>Durchgangsmaß: 1034x969</p> | 1 | | |
| | <p>TÜR 1425x1955</p>  <p>TU3-GH+</p> <p>L1 18x90 L=1665mm 2 Stck. L2 18x90 L=1955mm 4 Stck. ✓ WL1 36x129 L=1665mm 1 Stck.</p> <p>DIN rechts</p> <p>Durchgangsmaß: 1337x1867</p> | 1 | | |
| SR03 | SCHRAUBEN 3.5x45 |  | 48 | |
| SR05 | SCHRAUBEN 4.0x60 |  | 7 | |

✓ - Bitte selber anpassen

15.03.2017

Wandplan 3

Fenster und Türen 845110

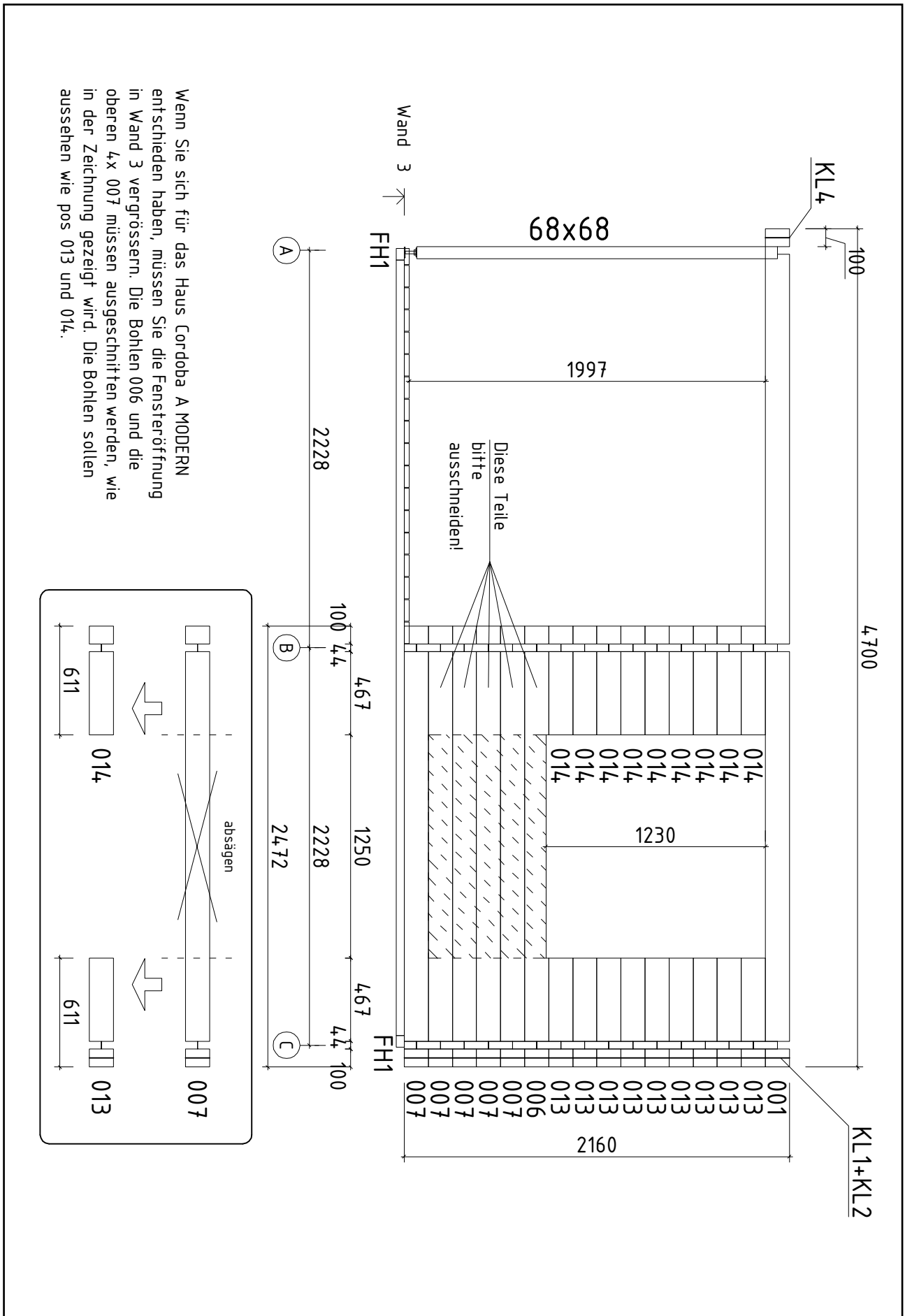

Wenn Sie sich für das Haus Cordoba A MODERN entschieden haben, müssen Sie die Fensteröffnung in Wand 3 vergrößern. Die Bohlen 006 und die oberen 4x 007 müssen ausgeschnitten werden, wie in der Zeichnung gezeigt wird. Die Bohlen sollen aussehen wie pos 013 und 014.