

Technische Daten: Art.-Nr.: 870520

Wandaußenmaß: 390 x 390 cm

Bohlenstärke: 70 mm



Durch Kunden farblich endbehandelt

Kontrolliert durch:

Empty rectangular box for signature or name.

Achtung: Alle angegebenen Maße sind ca.-Maße!

3D-Darstellung und Grundriss 870520

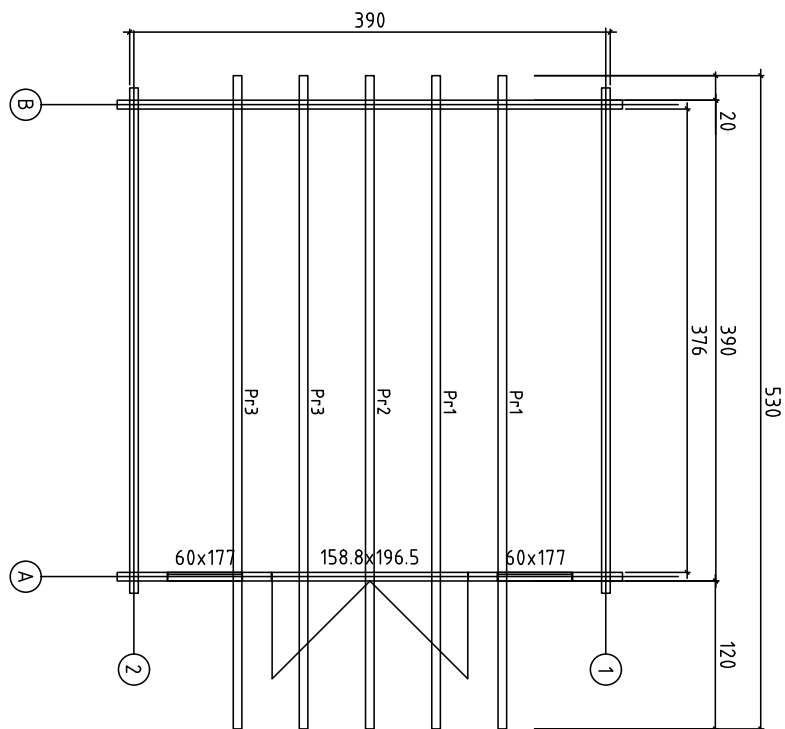
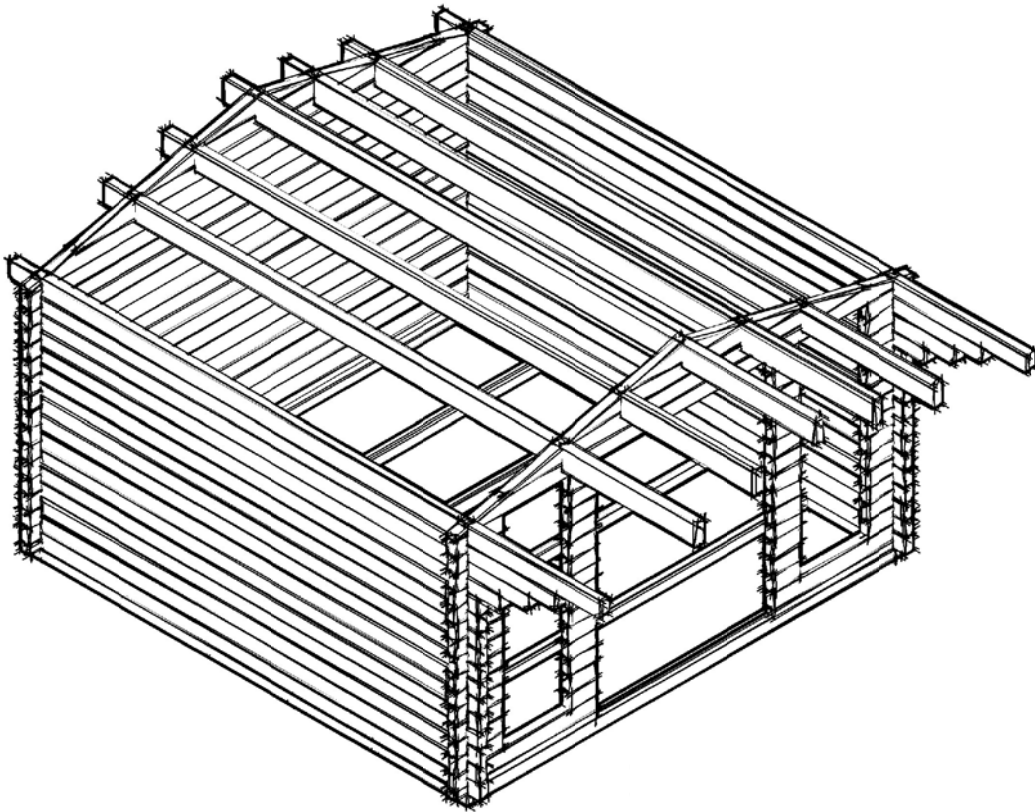





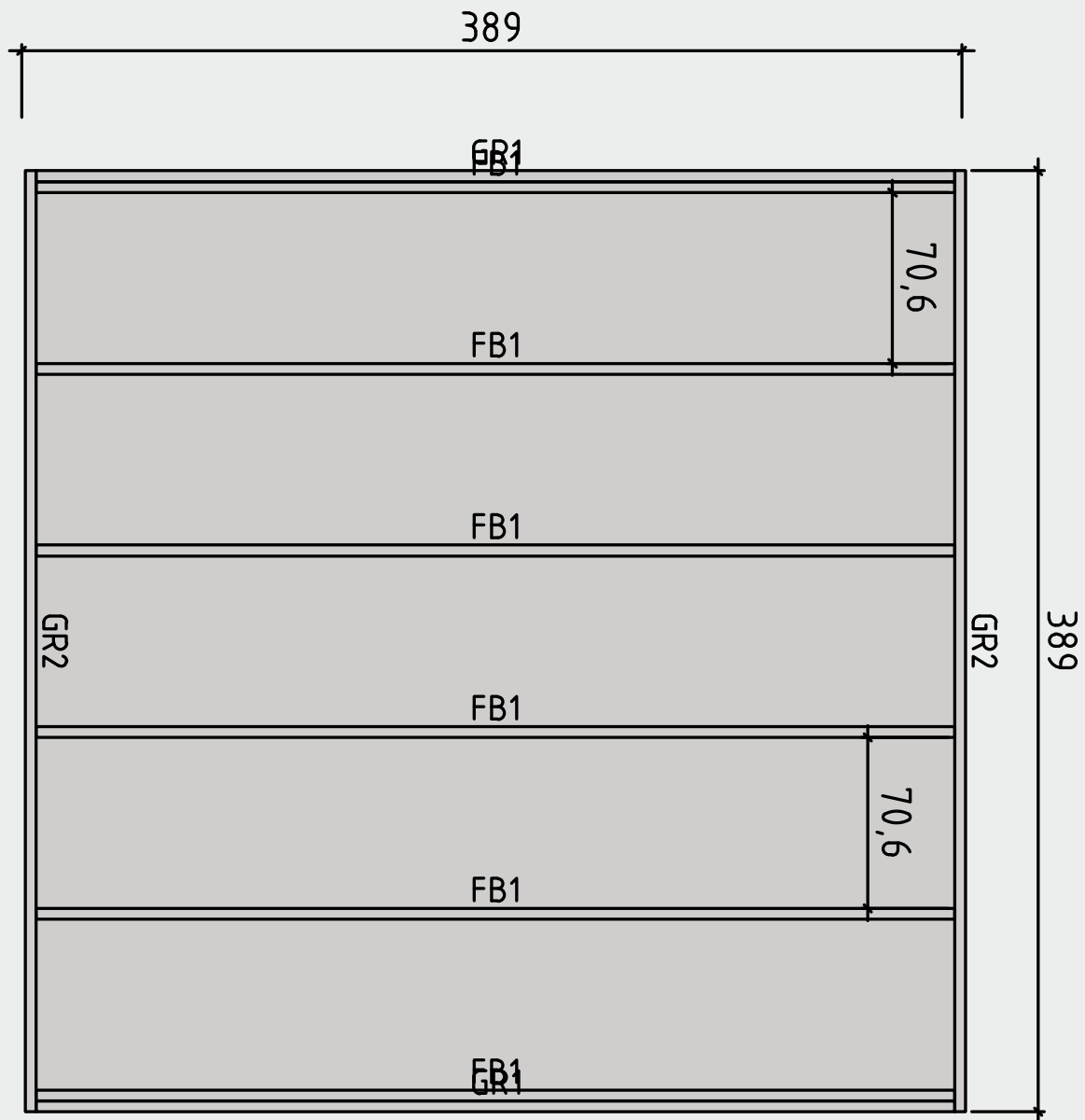





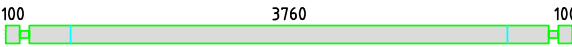

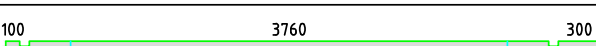
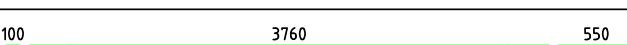
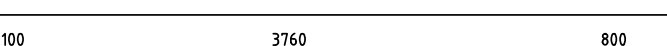
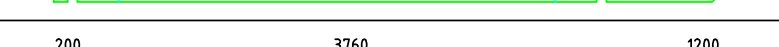
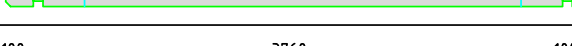
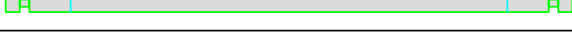
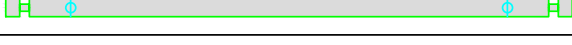
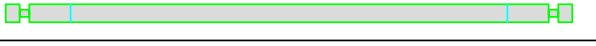
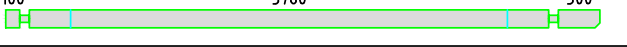
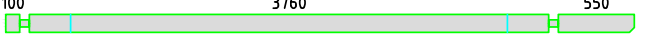

Lagerholzplan und Fundamentplan 870520

Wir empfehlen als Fundament für Ihr Gartenhaus eine vollflächig,
festgegründete gepflasterte oder betonierte Fläche.
Wahlweise ist auch ein Punkt- oder Streifenfundament möglich.

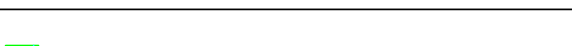

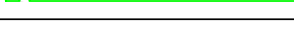
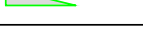

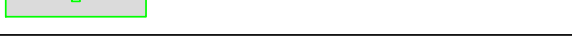







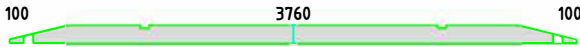
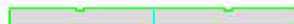

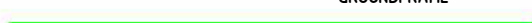

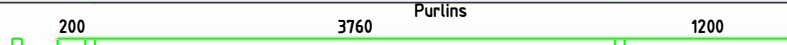

Teileliste 1

870520

Pos		Arv	Profile (mm)	LENGHT (mm)
001		1	70x130	4100
002		1	70x130	4100
003		10	70x130	4100
004		1	70x130	4300
005		1	70x130	4550
006		1	70x130	4800
007		1	70x130	5300
008		1	70x130	4100
009		1	70x130	4100
010		10	70x130	4100
011		1	70x130	4300
012		1	70x130	4550
013		1	70x130	4800
014		1	70x130	5300
015		2	70x65	1251
016		2	70x130	1251
017		28	70x130	406
018		28	70x130	235
019		1	70x130	4100
020		12	70x123	507
021		1	70x130	2089
022		1	70x130	1014
023		1	70x65	4100
024		1	70x130	4100
025		14	70x130	4100















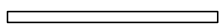

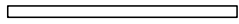
Teileliste 2

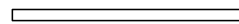
870520

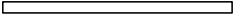
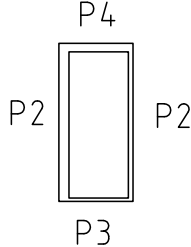
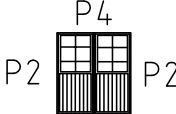
Pos		Arv	Profile (mm)	LENGHT (mm)
026		1	70x130	4100
027		1	70x130	2089
028		1	70x130	1014
GR2	GROUNDFRAME 	2	45x90	3890
GR1	GROUNDFRAME 	2	45x90	3800
FB1	FLOORBEAMS 	6	45x90	3800
Pr1	Purlins 	2	70x170	5300
Pr2	Purlins 	1	70x170	5300
Pr3	Purlins 	2	70x170	5300
	WINDOW 600x1770	2		
	DOOR 1588x1965	1		
1	Screws/Schrauben/Vis 5x100 mm- For fixing first row of wall logs /Fixierung des ersten Bohlenkranzes/Pour fixer les lamesde plancher 	6		
2	Nails/Nägel/Clous 2.5x50 - For fixing floorboards/ Befestigung Fussbodenbretter/Pour fixer les lames de plancher 	360		
3	Nails/Nägel/Clous 2.5x50 - For fixing roofboards/ Befestigung Dachbretter/Pour fixer les voliges 	500		
4	Nails/Nägel/Clous 2.5x50 - For fixing floor edge trims/ Befestigung Fussleisten/Pour fixer les plinthes du plancher 	30		
5	Nails/Nägel/Clous 2.5x50 - For fixing roofing felt fillet/ Befestigung giebelabschlussbrett/Pour fixer la latte de finition de la couverture 	20		
6	Screws/Schrauben/Vis 2,5x50 mm- For fixing roof side boards and roof edge reinforcement Befestigung Traufenbretter und Traufleisten Pour fixer les planches de rive et le tasseau de refrent 	44		
7	Screws/Schrauben/Vis 2,5x50 mm- For fixing fascia boards and diamonds/ Befestigung Giebelblende und Raute Pour fixer les planches de rive et le diamant 	28		
8	Screws/Schrauben/Vis 2,5x50 mm- For fixing fwindow and door trims/ Befestigung Fenster und türen/ Pour fixer les croisillons des fenetres et des portes 	44		
9	Metal storm Brace/Gewindestange/Tige filetee 10 mm  Plastic caps 5 pcs, Screws 180 10 pcs. KL1,KL2 M10 2,13 m 2+2 pcs. KL3 M10 2,45 m 1 pcs.	5		
10	Shim;Nuts/Mutter ,U-Scheibe/Ecrou;Rondelle 10 mm For fixing storm braces/ Pour fixer les anti tempete/ Für Sturmleisten Pour fixer les croisillons des fenetres et des portes 	5/5		

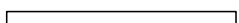
Teileliste 3

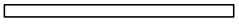
870520

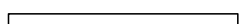
Specification for Hammerfest C 70x130 mm					
POS	ST.	B	H	L	ERKLÄRUNG
FB1	Vt. spetsi				 Fundamentholzer
F2	14,13 m ²	28		3755	 Fussbodenbretter 45/34/28
R1	5	70	170	5300	 Dachbalken
R2	23,96 m ²	20		2260	 Dachbretter 125/95/73
R3	2	20	120	5300	<small>Vaete kelluse kalcenurke</small>  Traufenbrett 
R4	2	45	65	5300	<small>Vaete kelluse kalcenurke</small>  Traufenbrett 
R5	4	20	120	2500	<small>Vaete kelluse kalcenurke</small>  Giebelblende 
R6	4	20	90	2500	 Giebelblende 
WN06	2	600	1770		 Sliding slats 30x30x1700 mm - 6 pcs.
DR16	1	1588	1965		
P1	20 m	20	40		 Fussbodenleiste
P2	12	20	90	1945	 Türleiste DR 16 
P3	2+2	20	90	540 570	 Türleiste und Fensterleiste DR 16, WN 07 
P4	2	20	90	3600	 Türleiste DR 16 

Wandplan 1 und 2 870520

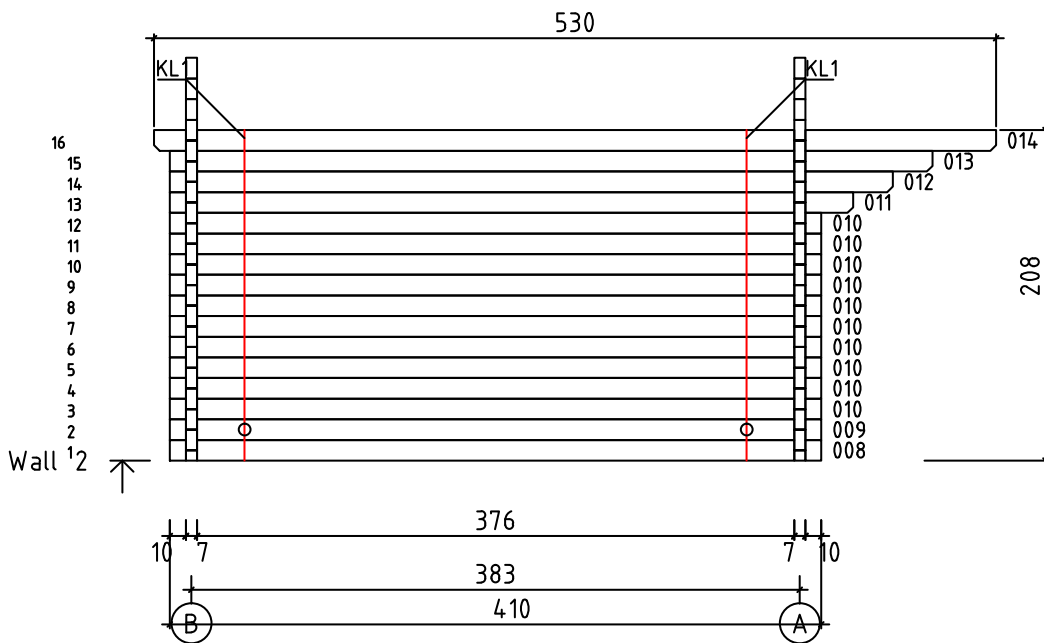
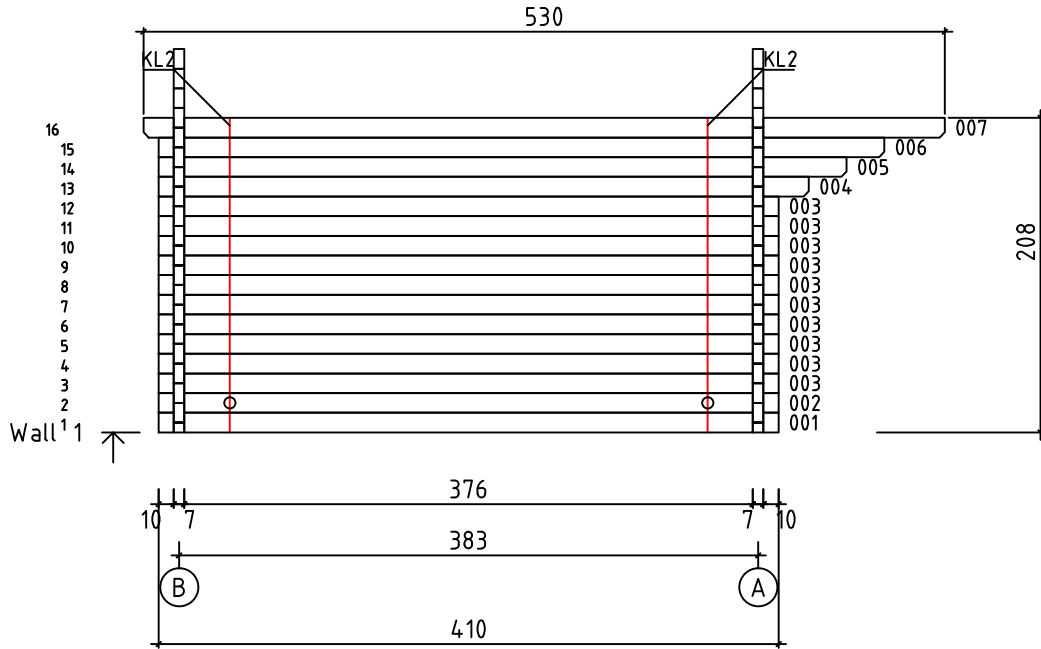

Wandplan A 870520

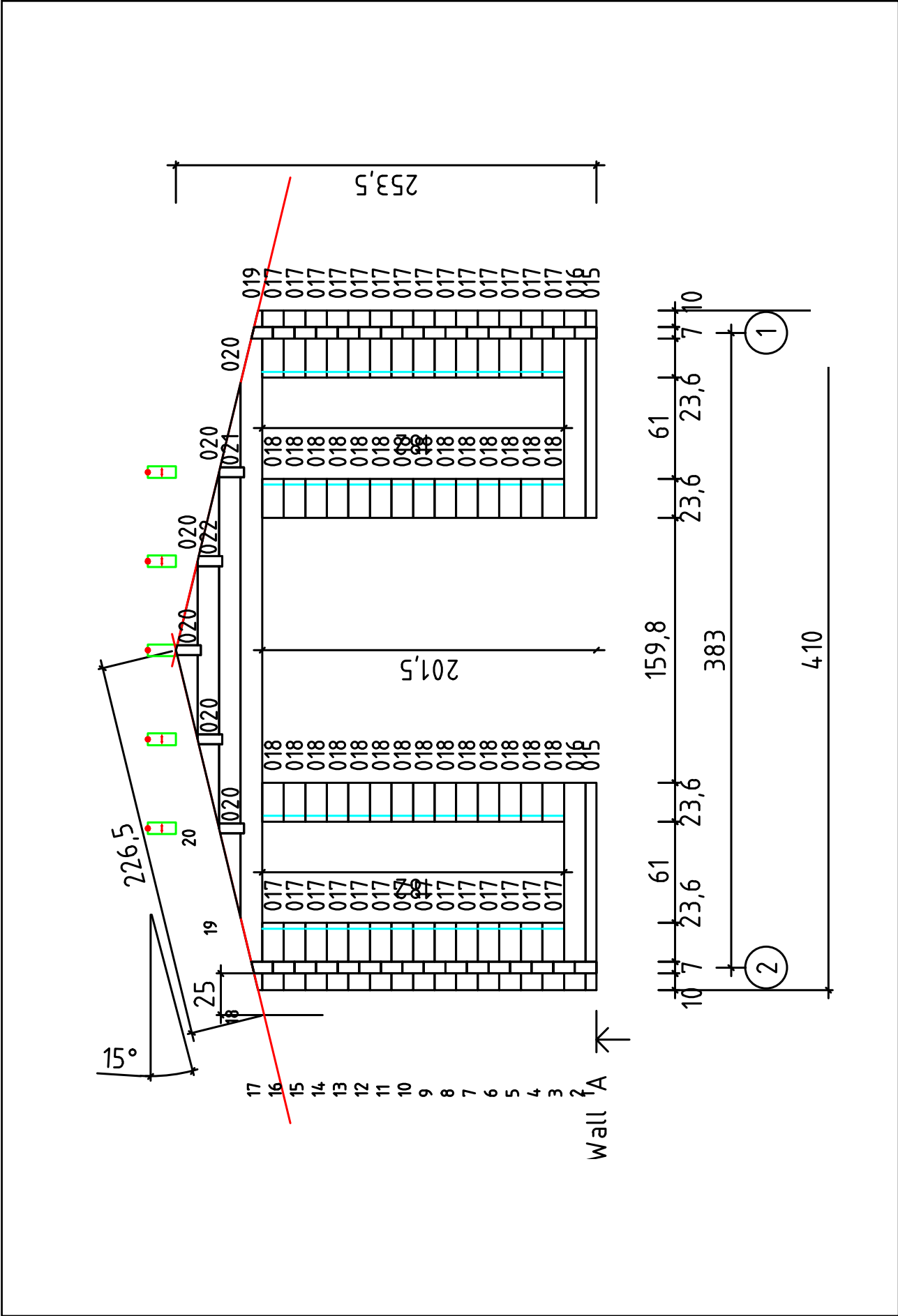

Wandplan B 870520

