

Technische Daten

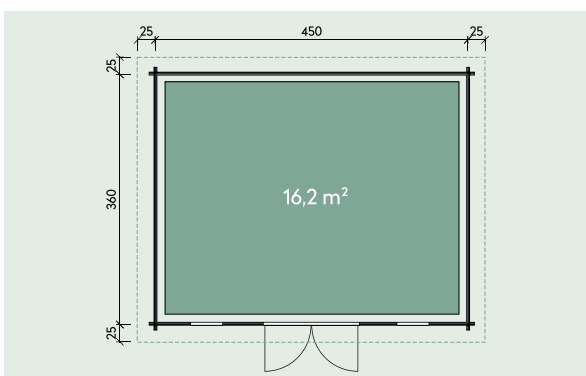

Artikelnummer:

871 530





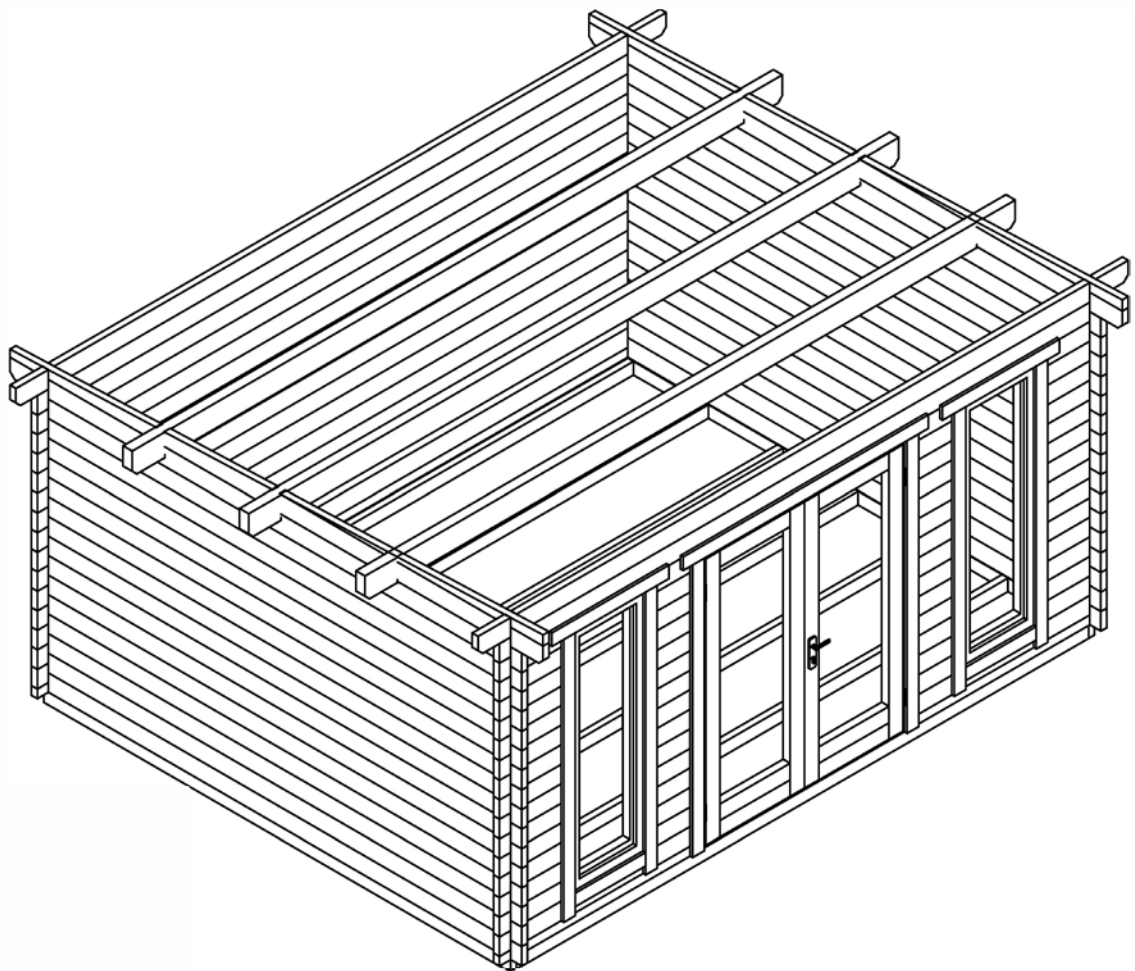

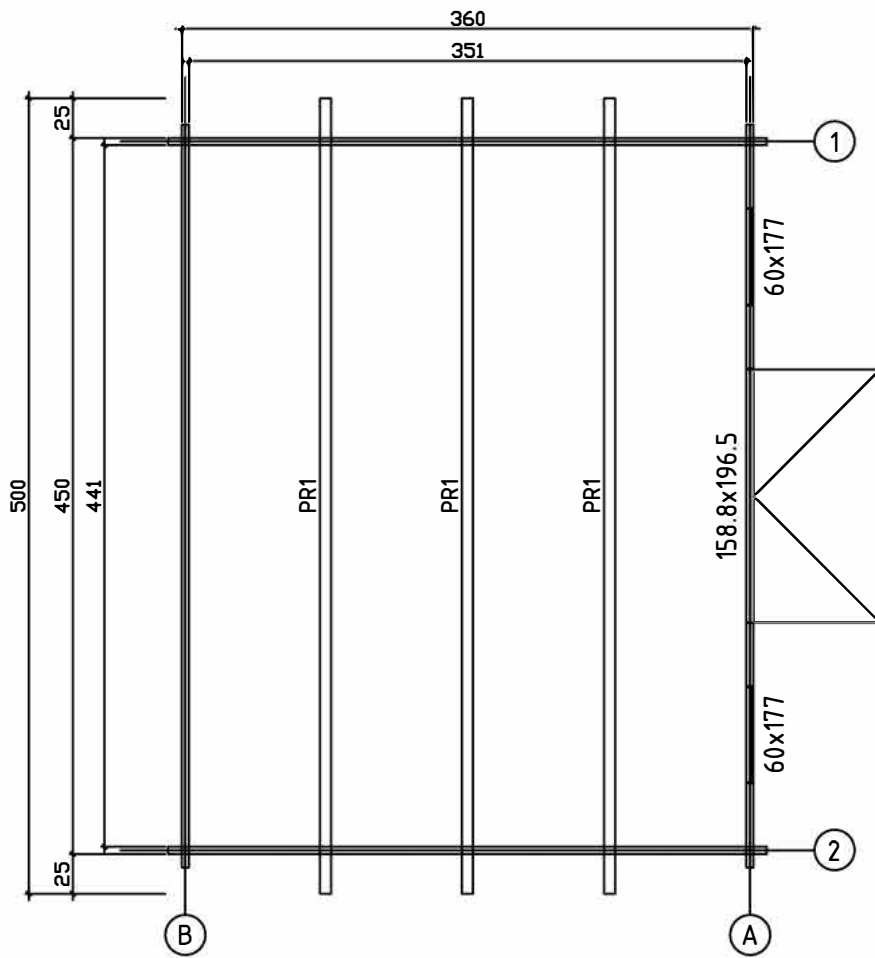



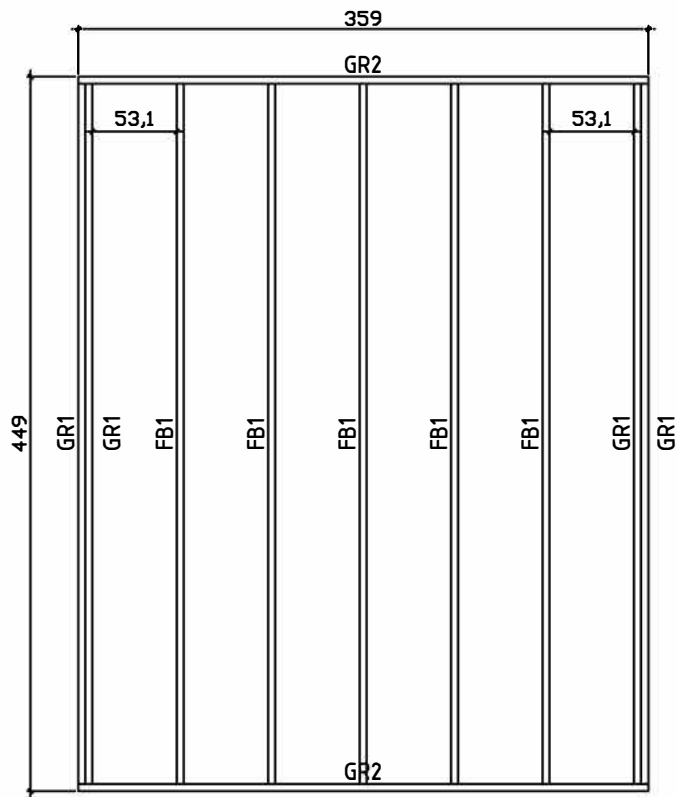

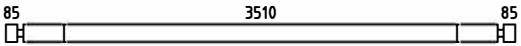
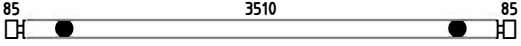
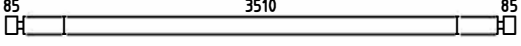
Kontrolliert durch:

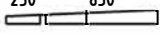
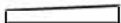

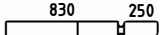
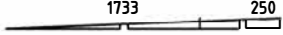
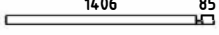
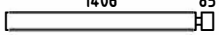

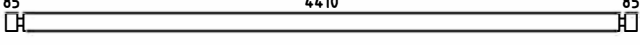
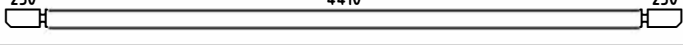
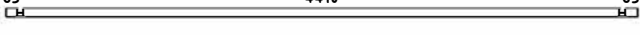



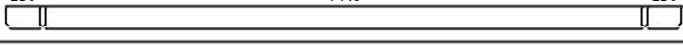

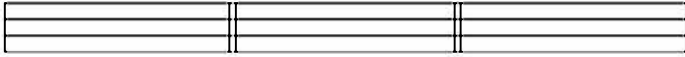
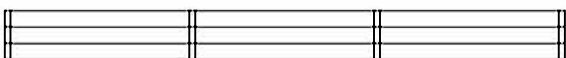



















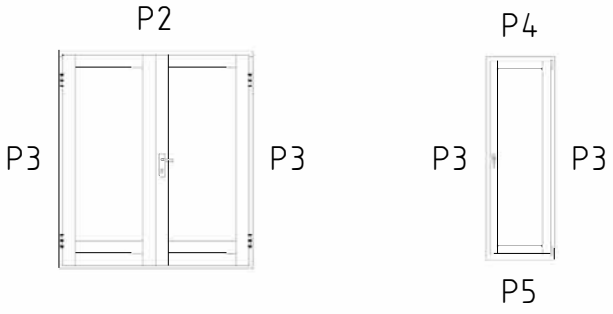

Wir empfehlen als Fundament für Ihr Gartenhaus eine vollflächig festgegründete, gepflasterte oder betonierte Fläche. Wahlweise ist auch ein Punkt- oder Streifenfundament möglich.



Pos		Quantity	Profil (mm)	Lenght (mm)
001		2	45x130	3770
002		2	45x130	3770
003		26	45x130	3770
004		2	45x130	3935
005		2	45x95	1125
006		2	45x128	835
007		2	45x130	835
008		2	45x130	1125
009		2	45x74	2028
010		2	45x65	1536
011		2	45x130	1536
012		28	45x130	528
013		28	45x130	398
014		16	45x130	4670
015		2	45x130	5000
016		1	45x65	4670
GR1		4	45x90	4400
GR2		2	45x90	3590
FB1		5	45x90	4400
PR1		3	70x170	5000
	WINDOW 600x1770	2		
	DOOR 1588x1965	1		

Pos		Quantity	Profil (mm)	Lenght (mm)
	<p>PARAPET R1 - 2 pcs.</p>  <p>PARAPET R2 - 2 pcs.</p> 			
1	<p>Screws/Schrauben/Vis 5x100 mm- For fixing first row of wall logs /Fixierung des ersten Bohlenkranzes/Pour fixer les lamesde plancher</p> 	6		
2	<p>Nails/Nägel/Clous 2.5x50 - For fixing floorboards/ Befestigung Fussbodenbretter/Pour fixer les lames de plancher</p> 	350		
3	<p>Nails/Nägel/Clous 2.5x50 - For fixing roofboards/ Befestigung Dachbretter/Pour fixer les voliges</p> 	350		
4	<p>Nails/Nägel/Clous 2.5x50 - For fixing floor edge trims/ Befestigung Fussleisten/Pour fixer les plinthes du plancher</p> 	30		
5	<p>Screws/Schrauben/Vis 2,5x50 mm- For fixing parapet / Befestigung parapet / Pour fixer les parapet</p> 	180		
6	<p>Screws/Schrauben/Vis 2,5x50 mm- For fixing window and door trims/ Befestigung Fenster und türen/ Pour fixer les croisillons des fenetres et des portes</p> 			
7	<p>Metal storm Brace/Gewindestange/Tige filetee 8 mm</p> 	4		
8	<p>Shim,Nuts/Mutter ,U-Scheibe/Ecrou,Rondelle 8 mm For fixing storm braces/ Pour fixer les anti tempete/ Für Sturmleisten Pour fixer les croisillons des fenetres et des portes</p>  <p>Metal storm Brace/Gewindestange/Tige filetee 8 mm KL1 M8 2,38 m 2 Screws 180 8 pcs. KL2 M8 2,28 m 2 Plastic caps 4 pcs.</p>	4/4		
9	<p>Roofing felt/Dachpappe/Feutre de toiture</p>	10+15		
10	<p>Nails/Nägel/Clous - For fixing roofing felt/ Befestigung Dachpappe/Pour fixer les feutre de toiture</p> 	220		

POS	ST.	B	H	L	Teileliste	
FB1	Vt. spetsi					FUNDMENTHOLZER 
F1	15,5m ²	28		3505		FUSSBODENBRETTER
PR	3	70	170	5000		DÄCHBALKEN 
RB1	20,5m ²	20		4103		DACHBRETTER
R1	2	20	360	5040		PARAPET
R2	2	20	360	4145		PARAPET
R3	2	45	45	5000	<input type="checkbox"/>	BEFESTIGUNG DACHBRETTER 
R4	2 2	45	90	250 295	<input type="checkbox"/>	BEFESTIGUNG PARAPET 
DR1 WN1	1 2	1588 600	1965 1770			
P1	17m	20	40			Fussbodenleiste
P2	1+1	20	90	1890		Türleiste DR1 
P3	6+6	20	90	1945		Türleiste DR1,WN1 
P4	2+2	20	90	900		Fensterleiste WN1 
P5	2+2	20	90	540 570		Fensterleiste WN1 