

# Technische Daten

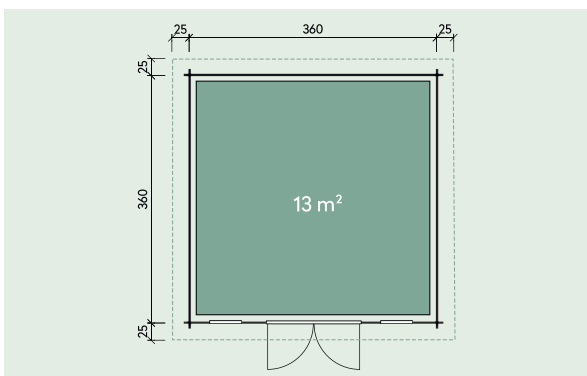

## Artikelnummer:

871 610





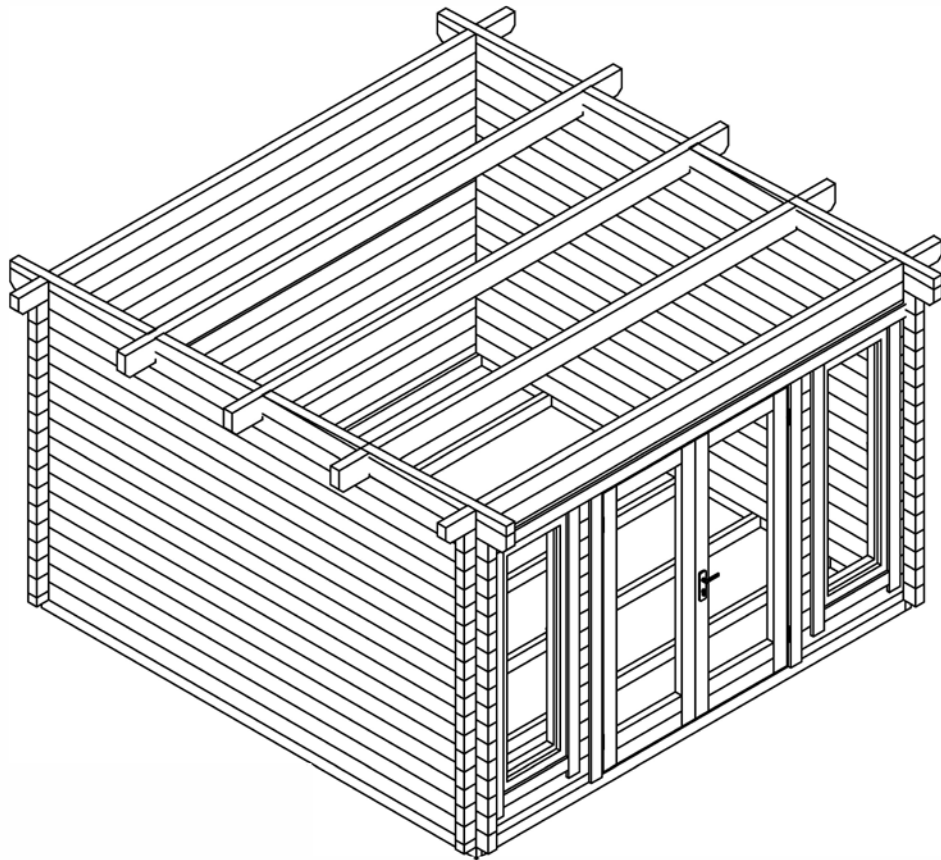

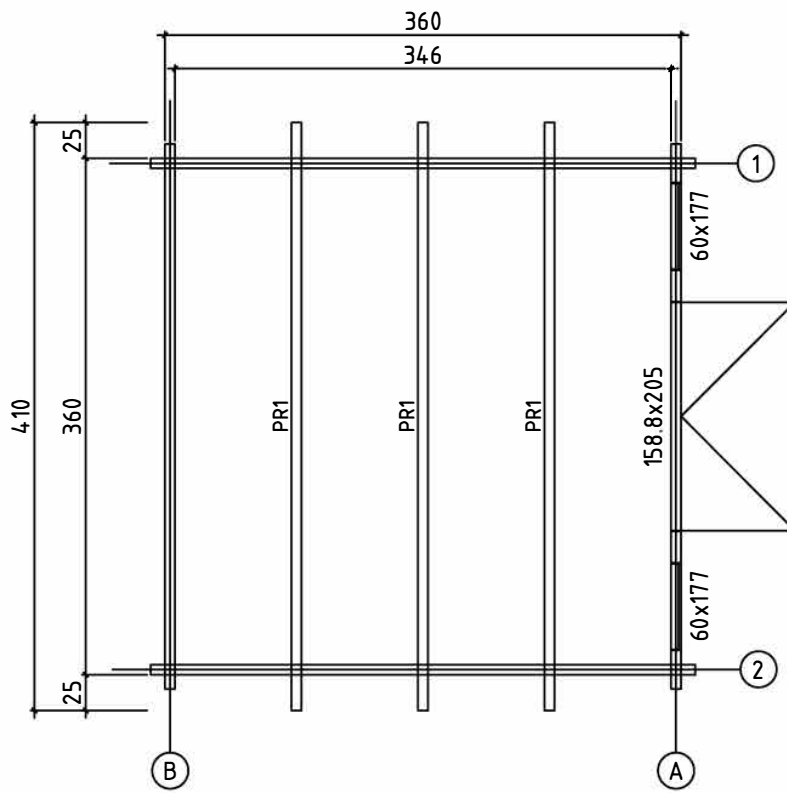



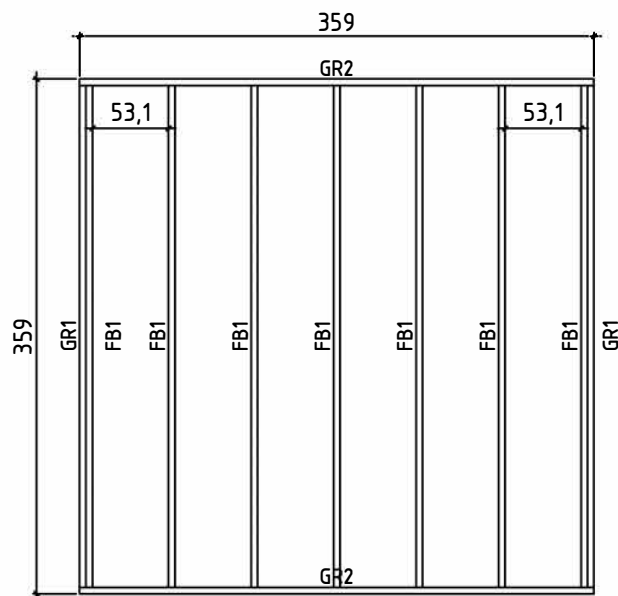

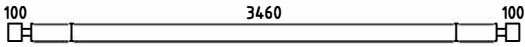
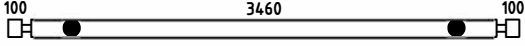
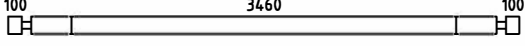
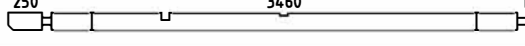
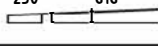
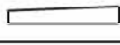
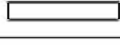
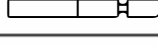
**Kontrolliert durch:**

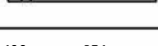
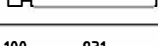
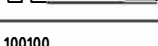

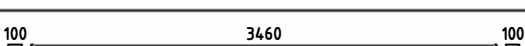
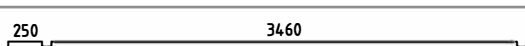
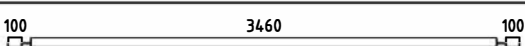



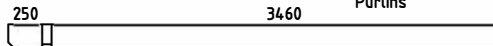



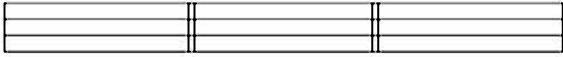
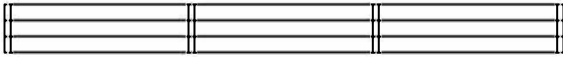











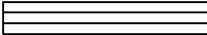
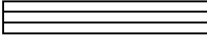

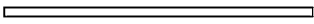

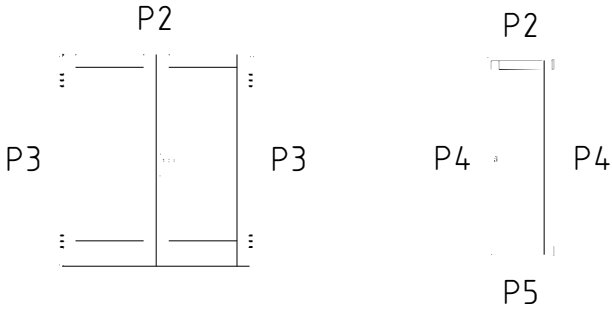
**Wir empfehlen als Fundament für Ihr Gartenhaus eine vollflächig festgegründete, gepflasterte oder betonierte Fläche. Wahlweise ist auch ein Punkt- oder Streifenfundament möglich.**

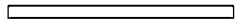

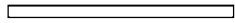
Pos		Quantity	Profil (mm)	Lenght (mm)
001		2	70x130	3800
002		2	70x130	3800
003		28	70x130	3800
004		2	70x130	3950
005		2	70x95	1138
006		2	70x128	823
007		2	70x130	823
008		2	70x130	1138
009		2	70x74	2015
010		2	70x65	1101
011		2	70x130	1101
012		2	70x130	1101
013		26	70x130	270
014		26	70x130	221
015		1	70x130	3800
016		17	70x130	3800
017		2	70x130	4100
018		1	70x65	3800
GR2		2	45x90	3590
GR1		2	45x90	3500
FB1		7	45x90	3500
PR1		3	70x170	4100
	WINDOW 600x1770	2		
	DOOR 1588x2050	1		

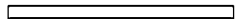
Pos		Quantity	Profil (mm)	Lenght (mm)
	<p>PARAPET R1 - 2 pcs.</p>  <p>PARAPET R2 - 2 pcs.</p> 			
1	<p>Screws/Schrauben/Vis 5x100 mm- For fixing first row of wall logs /Fixierung des ersten Bohlenkranzes/Pour fixer les lames de plancher</p> 	6		
2	<p>Nails/Nägel/Clous 2.5x50 - For fixing floorboards/ Befestigung Fussbodenbretter/Pour fixer les lames de plancher</p> 	275		
3	<p>Nails/Nägel/Clous 2.5x50 - For fixing roofboards/ Befestigung Dachbretter/Pour fixer les voliges</p> 	275		
4	<p>Nails/Nägel/Clous 2.5x50 - For fixing floor edge trims/ Befestigung Fussleisten/Pour fixer les plinthes du plancher</p> 	30		
5	<p>Screws/Schrauben/Vis 2,5x50 mm- For fixing parapet / Befestigung parapet / Pour fixer les parapet</p> 	145		
6	<p>Screws/Schrauben/Vis 2,5x50 mm- For fixing window and door trims/ Befestigung Fenster und türen/ Pour fixer les croissilons des fenetres et des portes</p> 			
7	<p>Metal storm Brace/Gewindestange/Tige filetee 8 mm</p> 	4		
8	<p>Shim,Nuts/Mutter ,U-Scheibe/Ecrou,Rondelle 8 mm For fixing storm braces/ Pour fixer les anti tempete/ Für Sturmleisten Pour fixer les croissilons des fenetres et des portes</p> <p>Metal storm Brace/Gewindestange/Tige filetee 8 mm KL1 M8 2,51 m 2 Screws 180 8 pcs. KL2 M8 2,41 m 2 Plastic caps 4 pcs.</p> 	4/4		
9	<p>Roofing felt/Dachpappe/Feutre de toiture</p>	10+15		
10	<p>Nails/Nägel/Clous - For fixing roofing felt/ Befestigung Dachpappe/Pour fixer les feutre de toiture</p> 	180		

RB1	16,8m <sup>2</sup>	20		4103	 DACHBRETTER
R1	2	20	360	4140	 PARAPET
R2	2	20	360	4145	 PARAPET
R3	2	45	45	4100	 BEFESTIGUNG DACHBRETTER 
R4	2 2 2	45	90	250 295	 BEFESTIGUNG PARAPET 
DR1 WN1	1 2	1588 600	2050 1770	 <p style="text-align: right;">Sliding slats 30x30x1600 mm - 4 pcs.</p>	
P1	15m	20	40		 Fussbodenleiste
P2	1+1	20	90	3440	 Türleiste DR1,WN1 
P3	2+2	20	90	2030	 Türleiste DR1 
P4	4+4	20	90	1920	 Fensterleiste WN1 
P5	2+2	20	90	540 570	 Fensterleiste WN1 