

Technische Daten: Art.-Nr.: 871 789 mit Seitendach 400 cm links

Wandaußenmaß: 730 x 360 cm
Bohlenstärke: 70 mm



Der Fußboden wurde bauseits vom Kunden ergänzt.

Kontrolliert durch:

Achtung: Alle angegebenen Maße sind ca.-Maße!

Grundriss

871 789 mit Seitendach 400 cm links

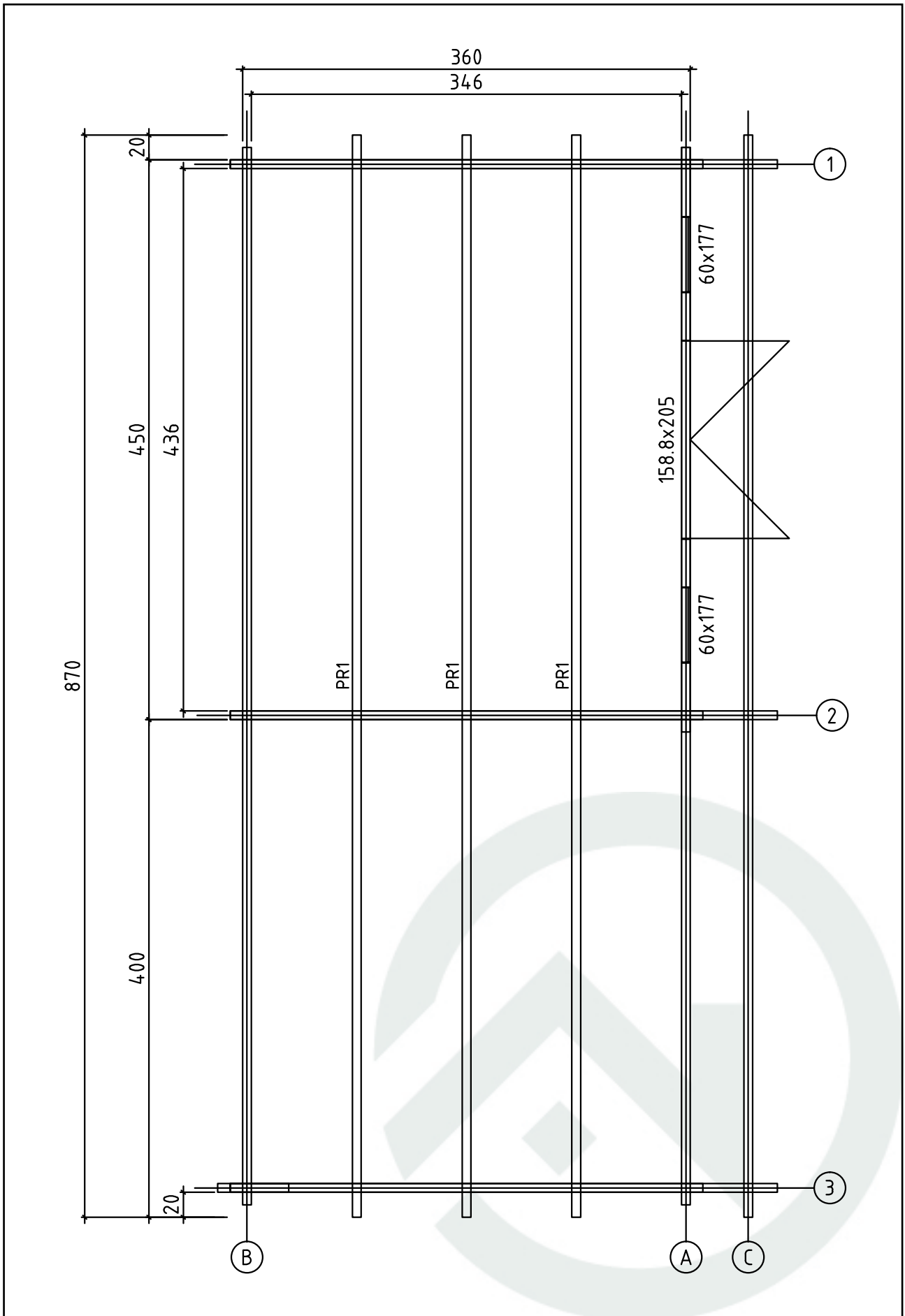





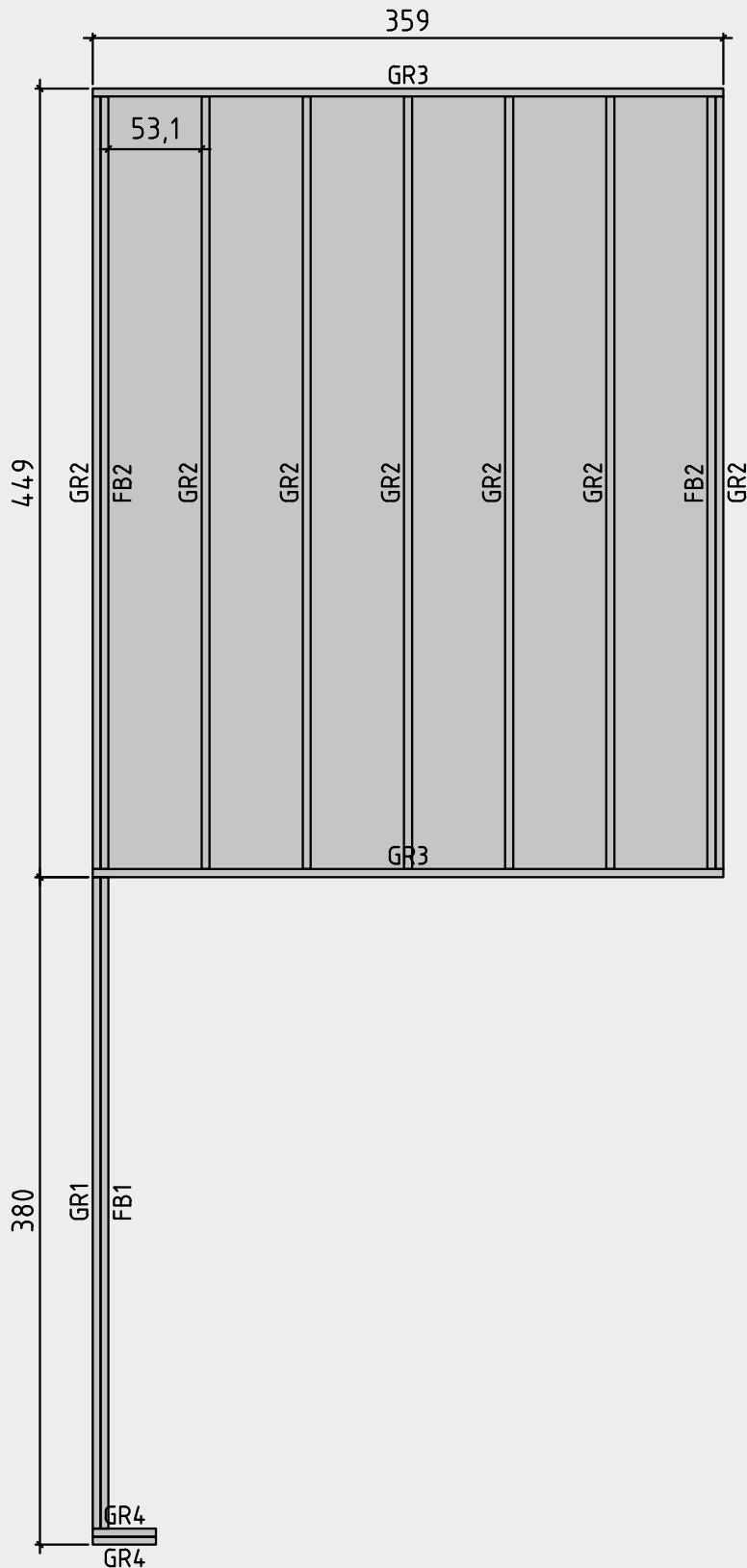





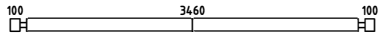
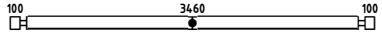
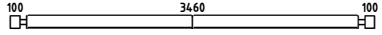
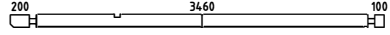
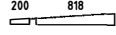

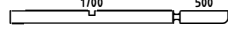

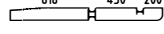
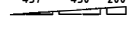
Lagerholzplan und Fundamentplan 871 789 mit Seitendach 400 cm links

Wir empfehlen als Fundament für Ihr Gartenhaus eine vollflächig festgegründete, gepflasterte oder betonierte Fläche.
Wahlweise ist auch ein Punkt- oder Streifenfundament möglich.

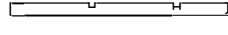



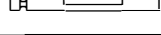

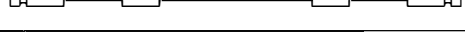
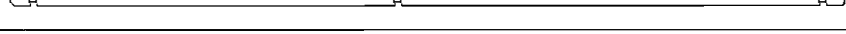
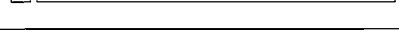
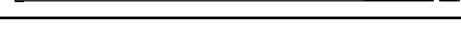
Teileliste 1

871 789 mit Seitendach 400 cm links

Pos			Profil (mm)	Lenght (mm)
001		2	70x130	3800
002		2	70x130	3800
003		26	70x130	3800
004		2	70x130	3900
005		3	70x118	1088
006		3	70x130	823
007		2	70x130	2270
008		3	70x45	693
009		2	70x102	852
010		3	70x130	1588
011		3	70x78	1207
012		1	70x130	470
013		14	70x130	470
014		1	70x130	3900
015		1	70x130	2270
016		1	70x102	852
017		2	70x65	1551
018		2	70x130	1551
019		2	70x130	1551
020		26	70x130	556
021		26	70x130	385
022		1	70x130	4700
023		1	70x130	8700
024		1	70x98	4035
025		1	70x98	4665

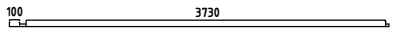
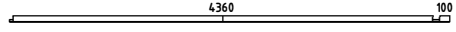
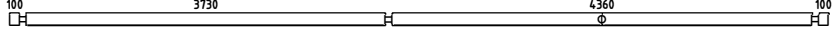
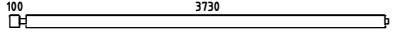
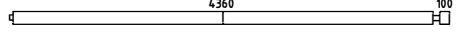
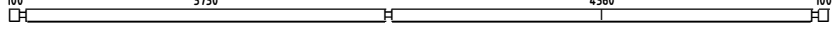
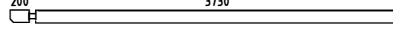
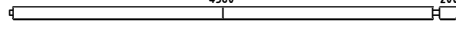
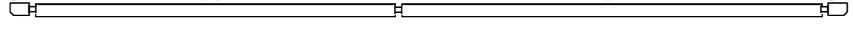
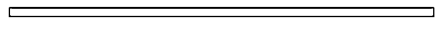

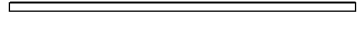

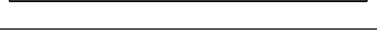
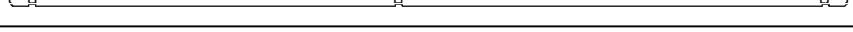







Teileliste 2

871 789 mit Seitendach 400 cm links

Pos			Profil (mm)	Lenght (mm)
026		1	70x65	3935
027		1	70x65	4565
028		1	70x130	8500
029		7	70x130	3935
030		7	70x130	4565
031		7	70x130	8500
032		1	70x130	4035
033		1	70x130	4665
034		1	70x130	8700
035	-	1	70x27	60
036	↓	2	70x27	60
GR2	GROUNDFRAME 	7	45x90	4400
GR1	GROUNDFRAME 	1	45x90	3710
GR3	GROUNDFRAME 	2	45x90	3590
GR4	GROUNDFRAME 	2	45x90	360
FB2	FLOORBEAMS 	2	45x90	4400
FB1	FLOORBEAMS 	1	45x90	3710
PR1	Purlins 	3	70x170	8700
	WINDOW 600x1770	2		
	DOOR 1588x2050	1		

Teileliste 3

871 789 mit Seitendach 400 cm links

1	Screws/Schrauben/Vis 5x100 mm- For fixing first row of wall logs /Fixierung des ersten Bohlenkranzes/Pour fixer les lames de plancher		6		
2	Nails/Nägel/Clous 2.5x50 - For fixing floorboards/ Befestigung Fussbodenbretter/Pour fixer les lames de plancher		350		
3	Nails/Nägel/Clous 2.5x50 - For fixing roofboards/ Befestigung Dachbretter/Pour fixer les voliges		600		
4	Nails/Nägel/Clous 2.5x50 - For fixing floor edge trims/ Befestigung Fussleisten/Pour fixer les pinthes du plancher		40		
5	Nails/Nägel/Clous 2.5x50 - For fixing roofing felt fillet/ Befestigung giebelabschlussbrett/Pour fixer la latte de finition de la couverture		40		
6	Screws/Schrauben/Vis 2.5x50 mm- For fixing roof side boards and roof edge reinforcement Befestigung Traufenbretter und Traufenleisten Pour fixer les planches de rive et le tasseau de refront		200		
7	Screws/Schrauben/Vis 2.5x50 mm- For fixing fascia boards and diamonds/ Befestigung Giebelblende und Raufe Pour fixer les planches de rive et le diamant				
8	Screws/Schrauben/Vis 2.5x50 mm- For fixing fwindow and door trims/ Befestigung Fenster und türen/ Pour fixer les croisillons des fenetres et des portes				
9	Metal storm Brace/Gewindestange/Tige filetee 10 mm		3		
10	Shim/Nuts/Mutter, U-Scheibe/Ecrou/Rondelle 10 mm For fixing storm braces/ Pour fixer les anti tempete/ Für Sturmleisten Pour fixer les croisillons des fenetres et des portes Metal storm Brace/Gewindestange/Tige filetee 10 mm KL1 M10 2,25 m 1 Screws 180 6 pcs. KL2 M10 2,44 m 2 Plastic caps 3 pcs.	   	3/3		

Teileliste 4

871 789 mit Seitendach 400 cm links

POS	ST.	B	H	L	Teileliste
FB1	Vt. spetsi				FUNDMENTHOLZER
F1	15,1m ²	28		3455	FUSSBODENBRETTER
PR	3	70	170	8700	DACHBALKEN
RB1	39,2m ²	20		4510	DACHBRETTER
R1	4	20	140	4370	<small>Vesta ketise kalenirka</small> Traufenbretter
R2	4	45	65	4350	<small>Vesta ketise kalenirka</small> Traufenbretter
R3	2	20	140	4710	<small>Vesta ketise kalenirka</small> Giebelabschlussleiste
R4	2	20	90	4710	Giebelabschlussleiste
PS1	1	120	120	2050	POSTS FOR SIDEROOF
WN06	2	600	1770		<p style="text-align: center;">Sliding slats 30x30x1600 mm - 4 pcs.</p>
DR16	1	1588	2050		
P1	17m	20	40		Fußbodenleiste
P2	4+4	20	90	1920	Fensterleiste WN 06
P3	2+2	20	90	900	Fensterleiste WN 06
P4	2+2	20	90	540 570	Fensterleiste WN 06
P5	2+2	20	90	2030	Türleiste DR 16
P6	1+1	20	90	1890	Türleiste DR 16

Detailzeichnungen

871 789 mit Seitendach 400 cm links

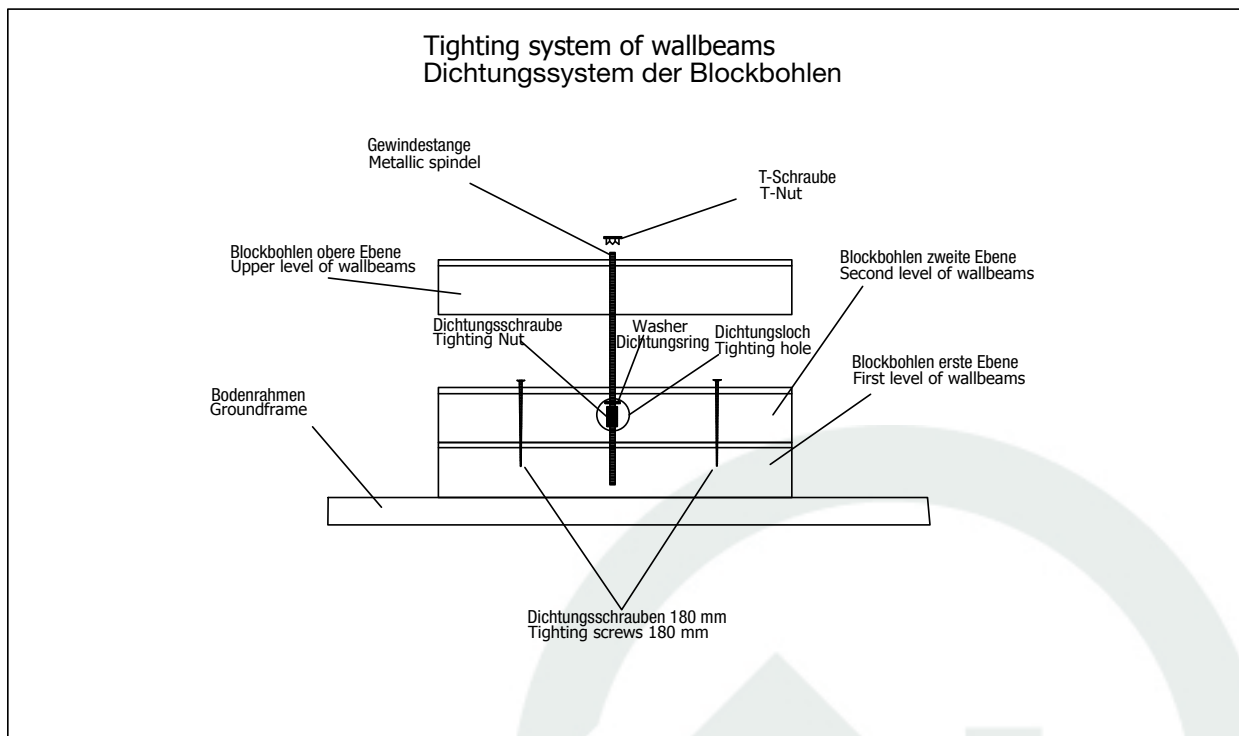
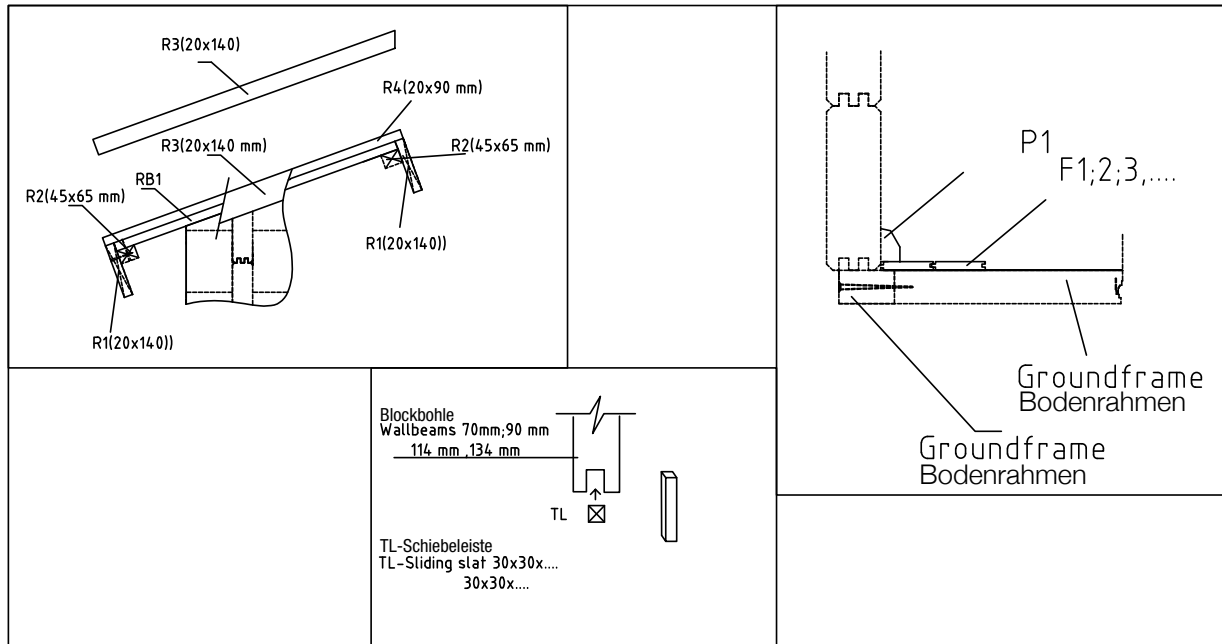

Wandplan 1 und 2

871 789 mit Seitendach 400 cm links

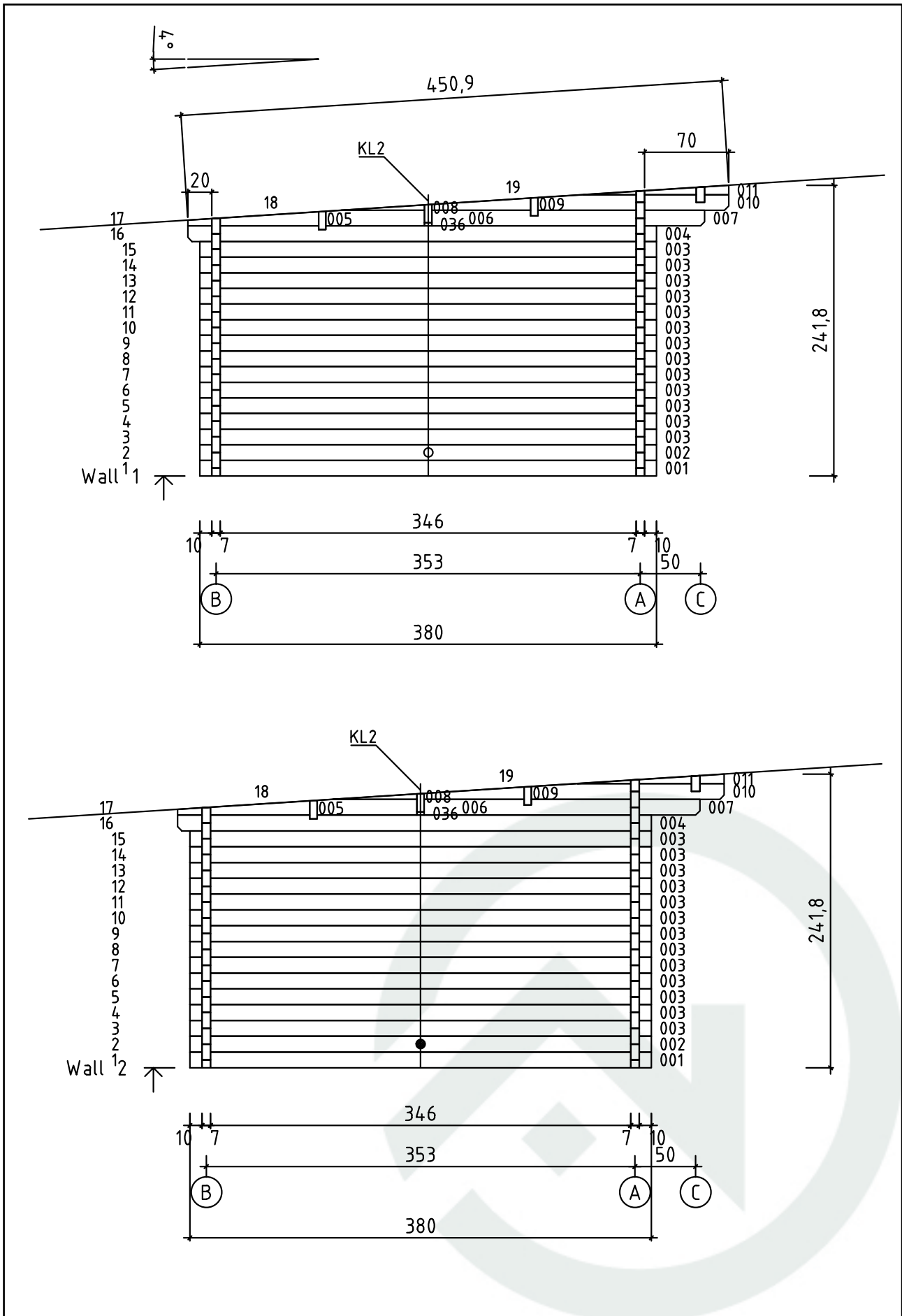

Wandplan 3

871 789 mit Seitendach 400cm links

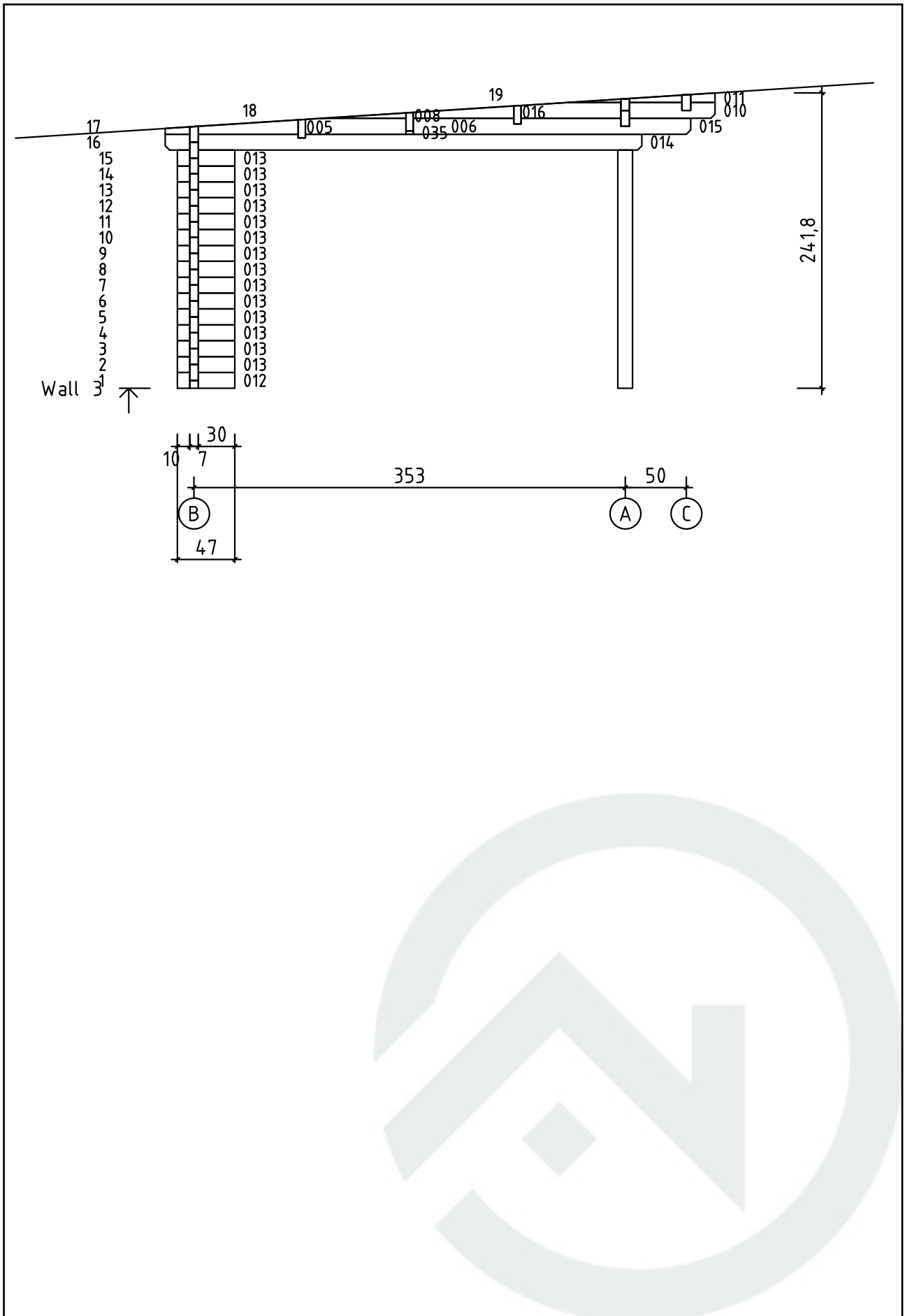

Wandplan A, B und C

871 789 mit Seitendach 400 cm links

