

# Pulti 34-C mit Türvariante Typ 2 (Halbglas-Tür)

Wandaußenmaß: 300 x 300 cm

Bohlenstärke: 34 mm



Kontrolliert durch:

Achtung: Alle angegebenen Maße sind ca.-Maße!

# 3D-Darstellung und Grundriss Pulti 34-C

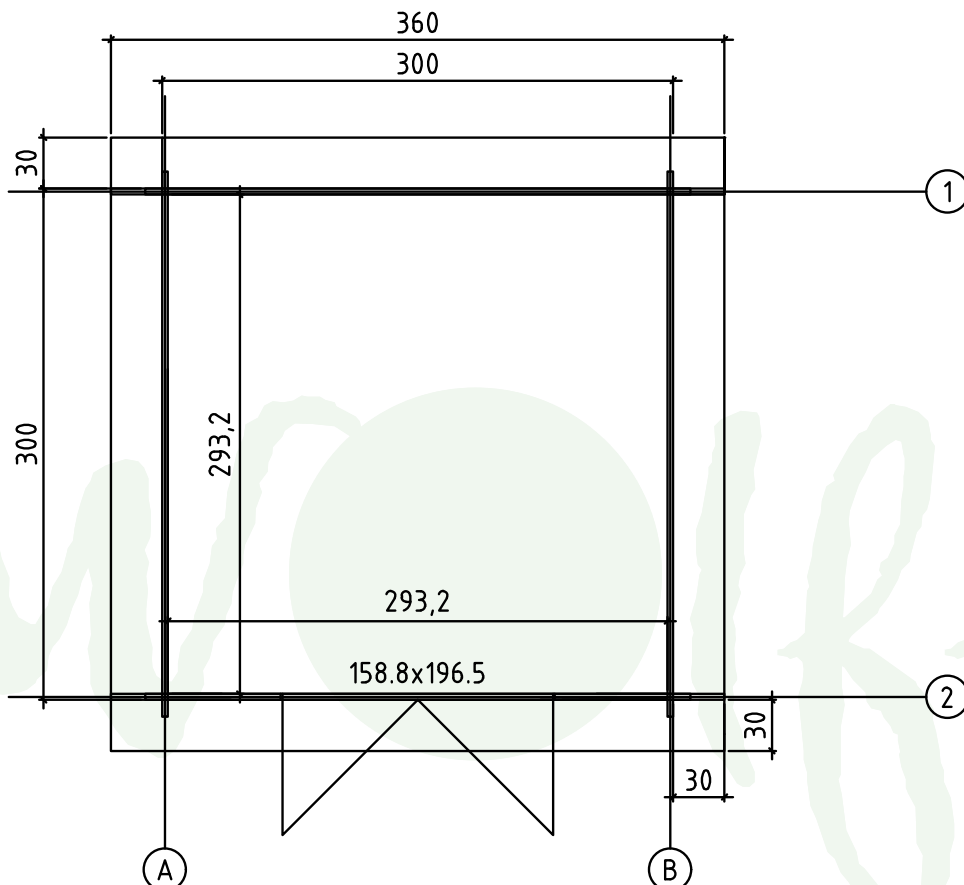
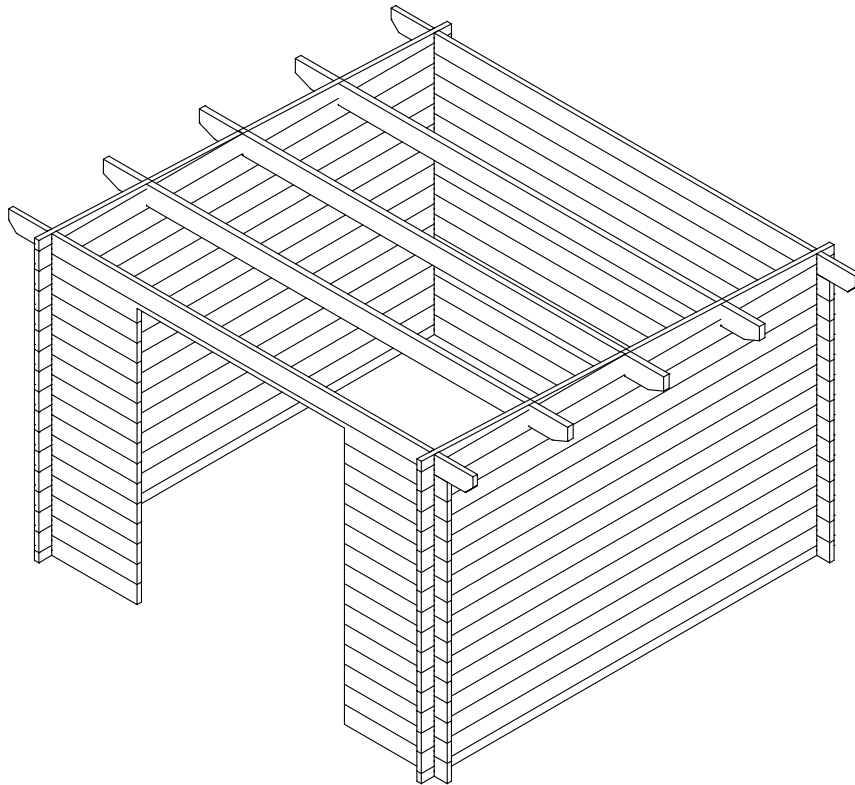





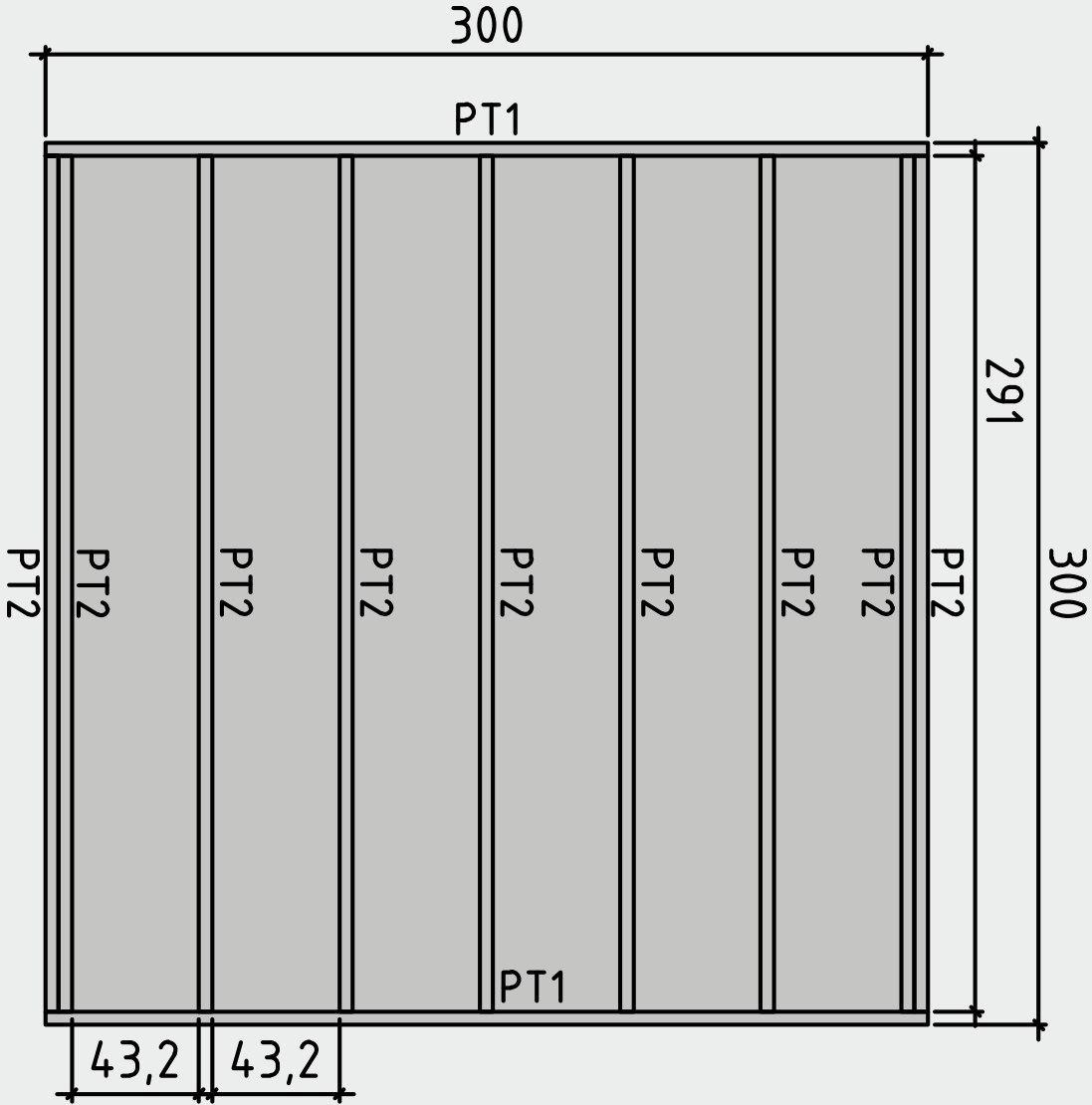

# Lagerholzplan und Fundamentplan Pulti 34-C

Wir empfehlen als Fundament für Ihr Gartenhaus eine vollflächig festgegründete, gepflasterte oder betonierte Fläche.  
Wahlweise ist auch ein Punkt- oder Streifenfundament möglich.

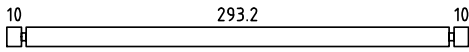
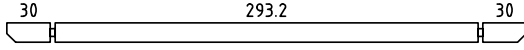
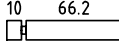
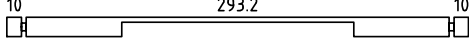
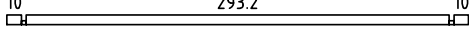
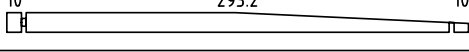
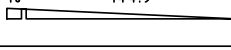
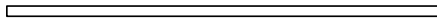
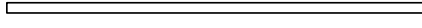
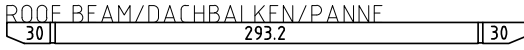
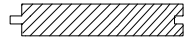









# Teileliste 1

## Pulti 34-C

Pos		Arv	Profile (cm)	Length (cm)
001		42	3.4x13.5	320
002		2	3.4x13.5	360
003		28	3.4x13.5	79.6
004		1	3.4x13.5	320
005		2	3.4x6.8	320
006		2	3.4x13.5	320
007		2	3.4x7.2	158.3
PT1	FOUNDATION/FUNDAMENT/SOLIVE 	2	4.5x7	300
PT2	FOUNDATION/FUNDAMENT/SOLIVE 	9	4.5x7	291
PR1	ROOF BEAM/DACHBALKEN/PANNE 	3	4.3x14.5	360
	DOOR 158.8x196.5 Tür nach Wahl	1		
007	FLOOR BOARDS/FUSSBODEN/LAME DE PLANCHER 	26 22	11.2x1.8 13.7x1.8	292.0 292.0
008	ROOF BOARDS/DACHBRETTER/VOLIGE 	32 26	11.2x1.8 13.7x1.8	360.5 360.5
009	ROOF EDGE REINFORCEMENT/TRAUFENLEISTE/TASSEAU 	2	2.6x3.2	360
010	FASCIA BOARD/GIEBELBLENDE/PLANCHE DE RIVE (FACADE) 	2	1.8x12.0	360.5
011	FASCIA BOARD/GIEBELBLENDE/PLANCHE DE RIVE (FACADE) 	2	1.8x12.0	363.6
012	STORM EDGE/STURMLEISTEN/STORM MOLDING 	4	2.6x3.2	2000
013	FLOOR EDGE TRIM/FUßLEISTEN/PLINTE PLANCHER 	4	2.0x4.5	2930

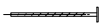
# Teileliste 2

## Pulti 34-C

Pos			Stück	Profile (cm)	Länge (cm)
014	METAL BOLT/SCHRAUBE/BOLT		8	M8	8
015	Shim, Nut/Mutter, U-Scheibe/Ecrou,Rondelle - M10 mm - For fixing storm braces/Pour fixer les anti-tempete/Für Sturmleisten		8	M8	
017	Nails/Nägels/Clous 2.5 x 50 mm - For fixing roofboards Befestigung Dachbretter/P our fixer les voliges		520		
018	Nails/Nägels/Clous 2.0 40 mm - For fixing roofing felt fillet (18 x 90 mm)/ Befestigung Giebelabschlussbrett (18 x 90 mm)/ Pour fixer la latte de finition de la couverture (18 x 90 mm)		20		
019	Screws/Schrauben/Vis 4 x 50 mm - For fixing roof side boards and roof edge reinforcement/Befestigung Traufenbretter und Traufenleisten Pour fixer les planches de rive et le tasseau (30 x 34 mm) de renfort		54		
020	Nails/Nägels/Clous 2.5 x 25 mm - For fixing floorboards/ Befestigung Fußbodenbretter/Pour fixer les lames de plancher		182		
021	Nails/Nägels/Clous 1.4 x 40 mm - For fixing floor edge trims (19 x 19 mm)/ Befestigung Fußleisten/Pour fixer les plinthes du plancher (19 x 19 mm)		24		
022	Screws/Schrauben/Vis 4x70 mm - For bearers/ Befestigung Fundamentbalken/Pour fixer les solives		28		
023	Roofing/Dachpappe		1		



# Wandplan 1 und 2 Pulti 34-C

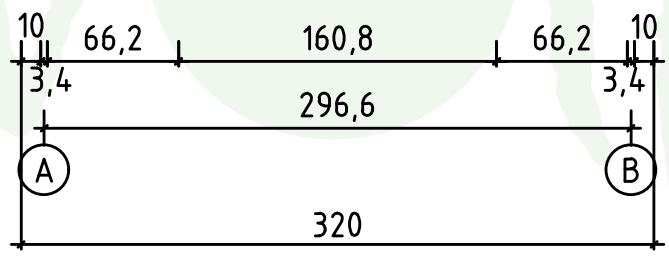
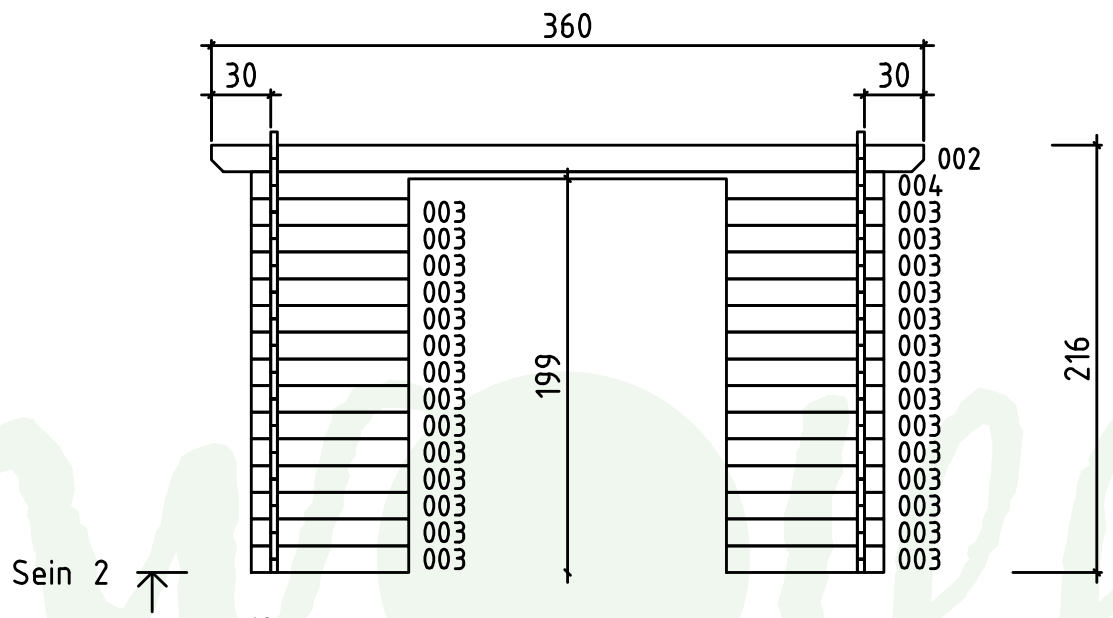
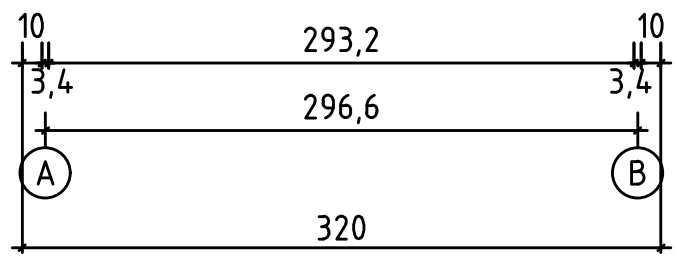
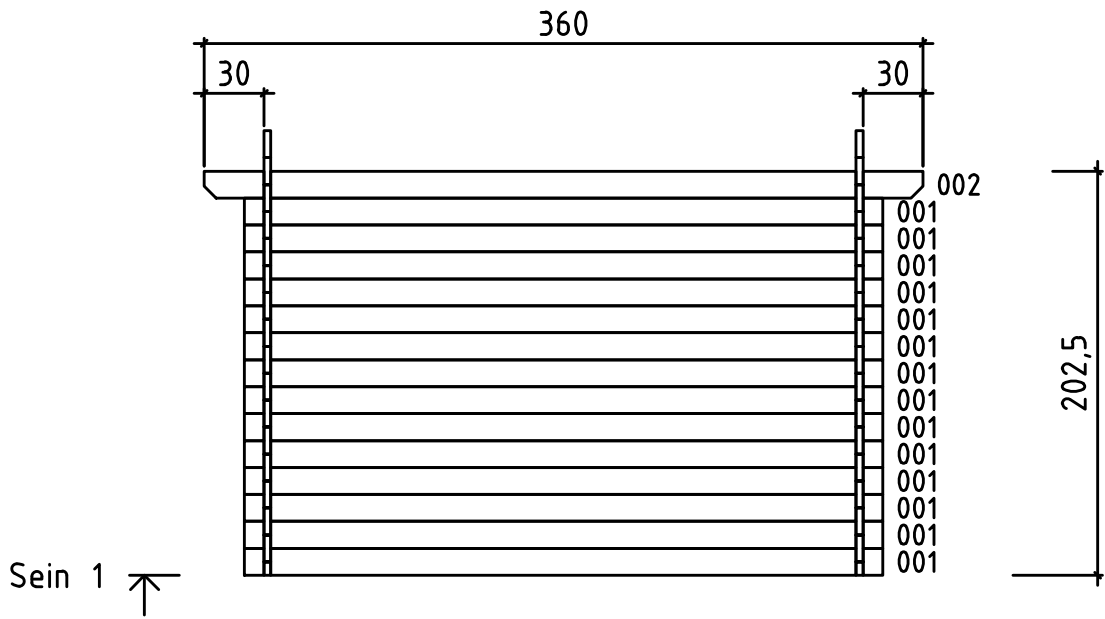

# Wandplan A Pulti 34-C

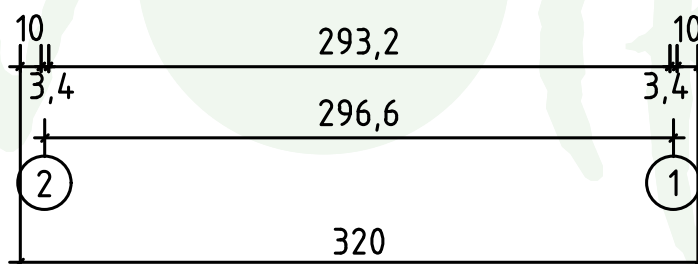
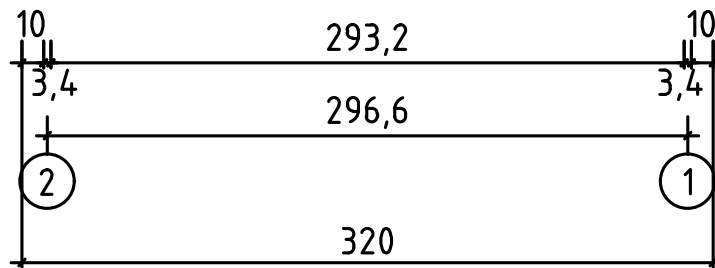
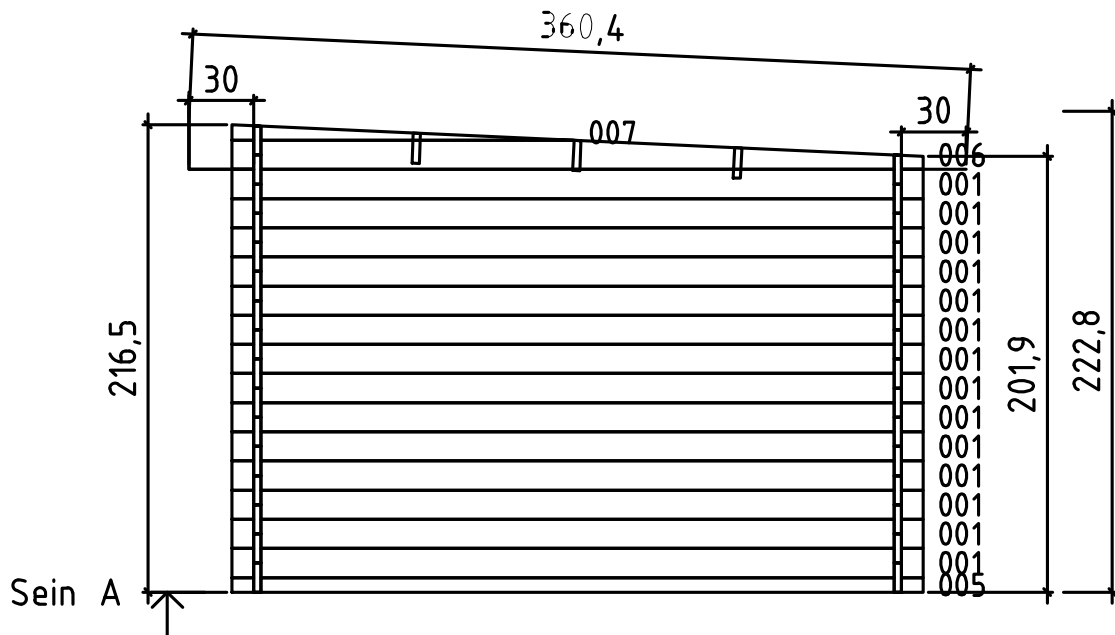



**Optional  
bei Türbestellung**

## AUFBAUANLEITUNG

Einzel- / Doppeltür

Kontroll-Nummer:

**wolff**  
Finnhaus



# Türmontage Einzel- / Doppeltür



# Türmontage Einzel- / Doppeltür

Zum Schluss die Türblätter. Zuerst wird mit der Wasserwaage der korrekte, senkrechte Sitz des Rahmens geprüft. Ggf. korrigieren. Nun können die Blätter eingehängt werden.

Unter Umständen ist ein Nachjustieren der Türen durch das Ein- oder Ausdrehen der Scharniere erforderlich.



Nur noch das Schloss einsetzen. (Abb. oben)

Wir empfehlen noch einen farblosen, oder pigmentierten Holzpflegeanstrich. Sprechen Sie mit uns, oder Ihrem Fachhändler.

Viel Freude an Ihrem neuen Gartenhaus wünscht Ihnen das Wolff-Team